



AUTO BEKABELING & CONNECTOREN

ACCESSOIRES & GEREEDSCHAP



EXPORT EUROPE & USA

Onthaal	+32 (0)2 648 35 17
Boekhouding	+32 (0)2 626 02 16
Fax	+32 (0)2 648 65 95
Informatie	info@casteels.fr
Bestellingen	orders@casteels.fr



Alphabetische index	3
Niet-geïsoleerde kabelschoenen	4
Oogkabelschoenen	4
Platte Standaard kabelschoenen	4
Hulzen voor platte Standaard kabelschoenen	4
Kabelschoenen voor "AMP" connectoren	4
Standaard cilinderkabelschoenen & voor "MATE-N-LOK" kast	4
Kabelschoenen voor krachtige kast	5
Kabelschoenen voor "AMP" Superseal aansluitingen en zekeringhouders	5
Kabelschoenen voor zekeringhouders en -kasten	5
Tweeslachtige kabelschoenen	5
Buisvormige soldeer- / krimpkabelschoenen	6
Oog soldeer- / krimpkabelschoenen	7
Krimpkabelverbindingsmoffen	7
Geïsoleerde kabelschoenen	8
Oogkabelschoenen	8
Mannelijke platte kabelschoenen	9
Vrouwelijke platte kabelschoenen	10
100% geïsoleerde vrouwelijke platte kabelschoenen	11
Mannelijke cilinderkabelschoenen	11
Mannelijke cilinderkabelschoenen - Nylon	12
Vrouwelijke cilinderkabelschoenen	12
Vrouwelijke cilinderkabelschoenen - Nylon	12
Verbindingshulzen - Vinyl	13
Verbindingshulzen - Nylon	13
Vorkkabelschoenen	13
Tweeslachtige klemmen	14
Eindstukjes	14
Oogkrimpkabelschoenen	15
Platte mannelijke krimpkabelschoenen	16
Platte vrouwelijke krimpkabelschoenen	16
100% geïsoleerde platte vrouwelijke krimpkabelschoenen	17
100% geïsoleerde platte mannelijke krimpkabelschoenen	17
Mannelijke cilinderkrimpkabelschoenen	18
Vrouwelijke cilinderkrimpkabelschoenen	18
Vorkkrimpkabelschoenen	18
krimpverbindingshulzen	19
Soldeer krimpverbindingshulzen	19
Zelfstrippende connectoren	19
Zelfstrippende connectoren T-TAP	20
Dubbel geïsoleerde mannelijke koppelingen	20
Y-verbinder - Platte kabelschoenen	20
Y-verbinder - Cilinderkabelschoenen	20
Kabeleindstukken	21
Set met kabeleindstukken (100 stk)	21
Set met kabeleindstukken (400 stk)	21
Kabelverbinders	21
Blisters met een mengeling van elektrische kabelschoenen	22
Gemengde blisters met elektrische kabelschoenen	22
Gemengde blister met thermische krimpverbindingshulzen	22

Gemengde blister met thermische soldeerverbindingshulzen	22
B blister met geïsoleerde kabelschoenen en krimptang	22
Dozen met kabelschoenen	23
Doos met 100 kabelschoenen	23
Doos met 220 kabelschoenen	23
Doos met 225 kabelschoenen	23
Doos met 300 kabelschoenen + tang	23
Doos met 535 kabelschoenen	24
Doos met 590 kabelschoenen, tang & 40 kabelklemmen	24
Doos met 775 kabelschoenen	24
Elektrische connectoren	25
AMP Superseal koppelingen 1,5mm	25
AMP Superseal koppelingen 2,8mm	25
Kabelschoenen voor AMP Superseal koppelingen	25
Stroomaansluitingen	26
Kabelschoenen voor stroomaansluitingen	26
"MATE-N-LOK" koppelingen	26
Kabelschoenen voor "MATE-N-LOK" koppelingen	26
Universele AMP koppelingen	27
Kabelschoenen voor universele AMP koppelingen	27
DEUTSCH koppelingen	27
Sets met koppelingen	28
Sets met waterdichte koppelingen	28
Koffer met AMP Superseal koppelingen	28
Electrische draden & kabels	29
Elektriciteitsdraad H05V-K / H07V-K rol	29
Elektriciteitsdraad H05V-K / H07V-K op bobijn	30
Elektriciteitsdraad H05V-K / H07V-K in doos	31
Elektriciteitsdraad H05V-K / H07V-K in blister	32
Multi-geleidingskabel A05VV-F op rol	33
Montagedraad / accudraad	33
FLKK "platte" kabel	34
Montage / accudraad	34
Kabelwartels	34
Doorvoertule (nylon)	35
Doorvoertule (rubber)	35
Verstelbare klemmen	35
Verstelbare zelfhechtende klemmen	35
Lusterklemmen	36
Lusterklemmen	36
Schroef lusterklemmen	36
Schroef distributie lusterklemmen	36
Waterdichte verdeeldoos	36
Elektrische draadgeleiders	37
Spiraalvormige draadgeleider	37
Snel draadgeleider	37
Soepele kabelbuis	37
Kabelbuis zonder snede	38
Kabelbuis met snede	38
Zelfdovend kabelbuis met snede	38
Bevestigingen voor draadgeleider - Plastiek	39
Bevestigingen voor draadgeleider met rubber bescherming	39

Rekbare gevlochten draadgeleider - Type BSPET	39
Rekbare gevlochten zelfdovende draadgeleider - Type BSPET	40
Warmtekrimpbare draadgeleider 2:1 - Type G5	40
Warmtekrimpbare draadgeleider 2:1 - Type G5	41
Warmtekrimpbare draadgeleider 2:1 - 5cm moffen in blister	41
Warmtekrimpbare draadgeleider 2:1 - Type G5	41
Warmtekrimpbare draadgeleider 2:1 - Type G5	42
Warmtekrimpbare tape 2:1 - Type HPVC	42
Warmtekrimpbare draadgeleider 3:1 - Type G5-3X	42
Warmtekrimpbare draadgeleider 3:1 - Type AIS-3X	42
Dozen met warmtekrimpbare draadgeleider 2:1 - Type G5	43
Kabelbinders	44
Nylon kabelbinders PA6.6	44
Nylon kabelbinders PA6.12	44
Onderzitters nylon PA.66	45
Set met kabelbinders (450 stk)	45
Set met kabelbinders (1000 stk)	45
Slangklemmen DIN 3017	46
Kabel accessoires & gereedschappen	47
Krimptangen	47
Klemmenset	47
Striptang	47
Laslamp	47
Soldeerdraad	47
Dubbelzijdige tape	48
PVC tape	48
Referentie index	49
Nota's	52

1	100% geïsoleerde platte mannelijke krimpkabelschoenen	17	O	Oog soldeer- / krimpkabelschoenen	7
	100% geïsoleerde platte vrouwelijke krimpkabelschoenen	17		Oogkabelschoenen	4, 8
	100% geïsoleerde vrouwelijke platte kabelschoenen	11		Oogkrimpkabelschoenen	15
A			P		
	AMP Superseal koppelingen 1,5mm	25		Platte mannelijke krimpkabelschoenen	16
	AMP Superseal koppelingen 2,8mm	25		Platte Standaard kabelschoenen	4
B				Platte vrouwelijke krimpkabelschoenen	16
	Bevestigingen voor draadgeleider - Plastiek	39		PVC tape	48
	Bevestigingen voor draadgeleider met rubber bescherming	39	R		
	Bliester met geïsoleerde kabelschoenen en krimptang	22		Rekbare gevlochten draadgeleider - Type BSPET	39
	Buisvormige soldeer- / krimpkabelschoenen	6		Rekbare gevlochten zelfdovende draadgeleider - Type BSPET	40
D			S		
	DEUTSCH koppelingen	27		Schroef distributie lusterklemmen	36
	Doorvoertule (nylon)	35		Schroef lusterklemmen	36
	Doorvoertule (rubber)	35		Set met kabelbinders (1000 stk)	45
	Doos met 100 kabelschoenen	23		Set met kabelbinders (450 stk)	45
	Doos met 220 kabelschoenen	23		Set met kabeleindstukken (100 stk)	21
	Doos met 225 kabelschoenen	23		Set met kabeleindstukken (400 stk)	21
	Doos met 300 kabelschoenen + tang	23		Sets met koppelingen	28
	Doos met 535 kabelschoenen	24		Sets met waterdichte koppelingen	28
	Doos met 590 kabelschoenen, tang & 40 kabelklemmen	24		Slangklemmen DIN 3017	46
	Doos met 775 kabelschoenen	24		Snel draadgeleider	37
	Dozen met warmtekrimpbare draadgeleider 2:1 - Type G5	43		Soepele kabelbuis	37
	Dubbel geïsoleerde mannelijke koppelingen	20		Soldeer krimpverbindingshulzen	19
	Dubbelzijdige tape	48		Soldeerdraad	47
E				Spiraalvormige draadgeleider	37
	Eindstukjes	14		Standaard cilinderkabelschoenen & voor "MATE-N-LOK" kast	4
	Elektriciteitsdraad H05V-K / H07V-K in blister	32		Striptang	47
	Elektriciteitsdraad H05V-K / H07V-K in doos	31		Stroomaansluitingen	26
	Elektriciteitsdraad H05V-K / H07V-K op bobijn	30	T		
	Elektriciteitsdraad H05V-K / H07V-K rol	29		Tweeslachtige kabelschoenen	5
F				Tweeslachtige klemmen	14
	FLKK "platte" kabel	34	U		
G				Universele AMP koppelingen	27
	Gemengde blister met thermische krimpverbindingshulzen	22	V		
	Gemengde blister met thermische soldeerverbindingshulzen	22		Verbindingshulzen - Nylon	13
	Gemengde blisters met elektrische kabelschoenen	22		Verbindingshulzen - Vinyl	13
H				Verstelbare klemmen	35
	Hulzen voor platte Standaard kabelschoenen	4		Verstelbare zelfhechtende klemmen	35
K				Vorkkabelschoenen	13
	Kabelbuis met snede	38		Vorkkrimpkabelschoenen	18
	Kabelbuis zonder snede	38		Vrouwelijke cilinderkabelschoenen	12
	Kabeleindstukken	21		Vrouwelijke cilinderkabelschoenen - Nylon	12
	Kabelschoenen voor "AMP" connectoren	4		Vrouwelijke cilinderkrimpkabelschoenen	18
	Kabelschoenen voor "AMP" Superseal aansluitingen en zekering	5		Vrouwelijke platte kabelschoenen	10
	Kabelschoenen voor "MATE-N-LOK" koppelingen	26	W		
	Kabelschoenen voor AMP Superseal koppelingen	25		Warmtekrimpbare draadgeleider 2:1 - 5cm moffen in blister	41
	Kabelschoenen voor krachtige kast	5		Warmtekrimpbare draadgeleider 2:1 - Type G5	40, 41, 42
	Kabelschoenen voor stroomaansluitingen	26		Warmtekrimpbare draadgeleider 3:1 - Type AIS-3X	42
	Kabelschoenen voor universele AMP koppelingen	27		Warmtekrimpbare draadgeleider 3:1 - Type G5-3X	42
	Kabelschoenen voor zekeringhouders en -kasten	5		Warmtekrimpbare tape 2:1 - Type HPVC	42
	Kabelverbinders	21		Waterdichte verdeeldoos	36
	Kabelwartels	34	Y		
	Klemmenset	47		Y-verbinder - Cilinderkabelschoenen	20
	Koffer met AMP Superseal koppelingen	28		Y-verbinder - Platte kabelschoenen	20
	Krimpkabelverbindingsmoffen	7	Z		
	Krimptangen	47		Zelfdovend kabelbuis met snede	38
	krimpverbindingshulzen	19		Zelfstrippende connectoren	19
L				Zelfstrippende connectoren T-TAP	20
	Laslamp	47			
	Lusterklemmen	36			
M					
	"MATE-N-LOK" koppelingen	26			
	Mannelijke cilinderkabelschoenen	11			
	Mannelijke cilinderkabelschoenen - Nylon	12			
	Mannelijke cilinderkrimpkabelschoenen	18			
	Mannelijke platte kabelschoenen	9			
	Montage / accudraad	34			
	Montagedraad / accudraad	33			
	Multi-geleidingskabel A05VV-F op rol	33			
N					
	Nylon kabelbinders PA6.12	44			
	Nylon kabelbinders PA6.6	44			
O					
	Onderzetters nylon PA.66	45			

OOGKABELSCHOENEN

M4 - M10

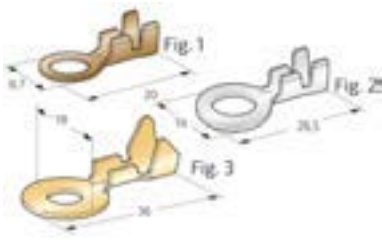

Artikelnummer				Opmerkingen		
Doos verpakking						
05.02970	0.5 mm	0.8 - 2.0 mm ²	M4		1	100
05.02980	0.6 mm	0.8 - 2.0 mm ²	M5		1	100
05.02981	0.6 mm	0.8 - 2.0 mm ²	M6		1	100
05.03016	0.8 mm	3.0 - 6.0 mm ²	M8		2	100
05.02550	0.7 mm	4.0 - 6.0 mm ²	M10		3	100

PLATTE STANDAARD KABELSCHOENEN

2,8 tot 9,5mm

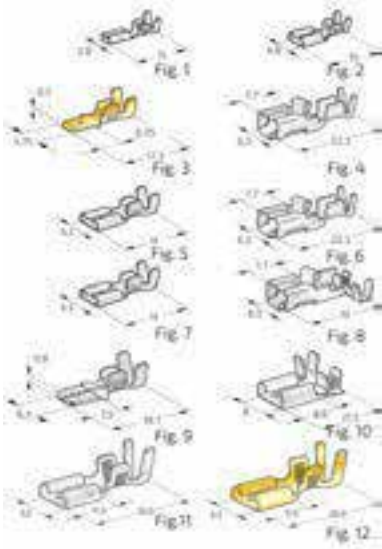

Artikelnummer				Opmerkingen		
Doos verpakking						
05.01390	2.8 x 0.3 mm	0.5 - 1.0 mm ²	F		1	200
05.01391	4.8 x 0.3 mm	0.5 - 1.0 mm ²	F		2	100
05.01417	4.8 x 0.5 mm	0.5 - 1.0 mm ²	M		3	200
05.00700	6.3 x 0.4 mm	0.5 - 1.5 mm ²	F		4	50
05.01402	6.3 x 0.4 mm	0.5 - 1.5 mm ²	F		5	100
05.00701	6.3 x 0.4 mm	2.5 - 4.0 mm ²	F		6	50
05.01400	6.3 x 0.4 mm	1.0 - 2.5 mm ²	F		7	200
05.00702	6.3 x 0.4 mm	1.0 - 2.5 mm ²	F		8	50
05.01412	6.3 x 0.8 mm	1.0 - 2.5 mm ²	M		9	100
05.01680	8.0 x 0.4 mm	1.0 - 2.5 mm ²	F		10	50
05.01720	9.5 x 0.4 mm	6.0 - 10.0 mm ²	F		11	100
05.01420	9.5 x 0.5 mm	2.0 - 4.0 mm ²	F		12	100

HULZEN VOOR PLATTE STANDAARD KABELSCHOENEN

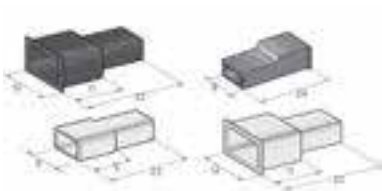

Artikelnummer	Beschrijving	
Doos verpakking		
05.10080	Mannelijke huls voor kabelschoenen 6,3mm	200
05.20080	Vrouwelijke huls voor kabelschoenen 6,3mm	50
05.10076	Vrouwelijke huls voor kabelschoenen 6,3mm	200
05.10086	Mannelijke huls voor kabelschoenen 6,3mm	200

KABELSCHOENEN VOOR "AMP" CONNECTOREN

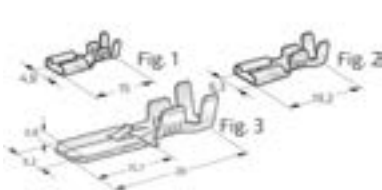

Artikelnummer				Opmerkingen		
Doos verpakking						
05.01710	4.8 x 0.32 mm	0.5 - 1.0 mm ²	F		1	100
05.01650	6.3 x 0.35 mm	1.0 - 2.5 mm ²	F		2	100
05.01660	6.3 x 0.8 mm	1.0 - 2.5 mm ²	M		1	100
05.01662	6.3 x 0.8 mm	4.0 - 6.0 mm ²	M		3	100

STANDAARD CILINDERKABELSCHOENEN & VOOR "MATE-N-LOK" KAST

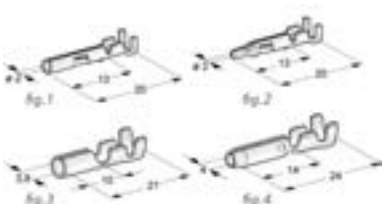

Artikelnummer				Opmerkingen		
Doos verpakking						
05.01200	dia. 2.0 mm	0.5 - 2.5 mm ²	F	"MATE-N-LOCK"	1	200
05.01210	dia. 2.0 mm	0.5 - 2.5 mm ²	M	"MATE-N-LOCK"	2	200
05.01110	dia. 4.0 mm	0.5 - 2.5 mm ²	F		3	100
05.01100	dia. 4.0 mm	0.5 - 2.5 mm ²	M		4	100

KABELSCHOENEN VOOR KRACHTIGE KAST

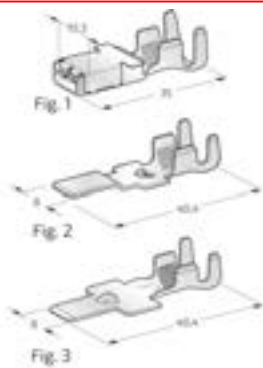

Artikelnummer				Opmerkingen		
Doos verpakking						
OS.07650	8.0 x 0.5 mm	1.5 - 2.5 mm ²	F		1	20
OS.07660	8.0 x 0.5 mm	4.0 - 6.0 mm ²	F		1	20
OS.07670	8.0 x 0.5 mm	8.0 - 10.0 mm ²	F		1	20
OS.07671	8.0 x 0.5 mm	16.0 mm ²	F		1	20
OS.07700	8.0 x 0.5 mm	2.5 - 4.0 mm ²	M		2	20
OS.07675	8.0 x 0.5 mm	2.5 - 4.0 mm ²	M		2	20
OS.07710	8.0 x 0.5 mm	6.0 - 8.0 mm ²	M		2	20
OS.07685	8.0 x 0.5 mm	6.0 - 8.0 mm ²	M		2	20
OS.07720	8.0 x 0.5 mm	10.0 - 16.0 mm ²	M		2	20
OS.07690	8.0 x 0.5 mm	10.0 - 16.0 mm ²	M		2	20

KABELSCHOENEN VOOR "AMP" SUPERSEAL AANSLUITINGEN EN ZEKERINGHOUDERS

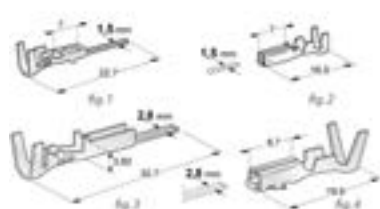

Artikelnummer				Opmerkingen			
Doos verpakking							
OS.05560	1.5 x 0.3 mm	0.5 - 1.5 mm ²	F	Serie 1,5mm	2	100	
OS.05550	1.5 x 0.32 mm	0.5 - 1.5 mm ²	M	Serie 1,5mm	1	100	
OS.04500	2.8 x 0.4 mm	1.5 - 2.5 mm ²	M	Serie 2,8mm	3	50	
OS.04510	2.8 x 0.4 mm	1.5 - 2.5 mm ²	F	Serie 2,8mm	4	100	
Artikelnummer	Beschrijving						
Doos verpakking							
OS.07740	Waterdichte pakking						100
OS.07750	Waterdichte pakking						100

KABELSCHOENEN VOOR ZEKERINGHOUDERS EN -KASTEN

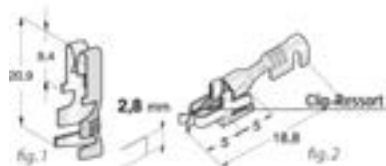

Artikelnummer			Opmerkingen		
Doos verpakking					
OS.07900	0.4 mm	1.0 - 2.5 mm ²			100
OS.07901	0.4 mm	2.5 - 6.0 mm ²			100
OS.07209	2.8 x 0.4 mm	0.5 - 1.0 mm ²			100
OS.07212	2.8 x 0.4 mm	1.5 - 2.5 mm ²			100

TWEESLACHTIGE KABELSCHOENEN



Artikelnummer			Opmerkingen		
OS.01501	6.3 x 0.4 mm	0.8 - 2.5 mm ²			100
OS.01500	6.3 x 0.4 mm				100

BUIJVORMIGE SOLDEER- / KRIMPKABELSCHOENEN

10-95mm²

Artikelnummer			Opmerkingen	
Doos verpakking				
OS.61006	10 mm ²	M6	Vertind messing	25
OS.61008	10 mm ²	M8	Vertind messing	25
OS.61606	16 mm ²	M6	Vertind messing	25
OS.61608	16 mm ²	M8	Vertind messing	25
OS.62506	25 mm ²	M6	Vertind messing	25
OS.62508	25 mm ²	M8	Vertind messing	25
OS.62510	25 mm ²	M10	Vertind messing	25
OS.63506	35 mm ²	M6	Vertind messing	25
OS.63508	35 mm ²	M8	Vertind messing	25
OS.63510	35 mm ²	M10	Vertind messing	25
OS.65008	50 mm ²	M8	Vertind messing	25
OS.65010	50 mm ²	M10	Vertind messing	25
OS.67008	70 mm ²	M8	Vertind messing	25
OS.67010	70 mm ²	M10	Vertind messing	25
OS.67013	70 mm ²	M13	Vertind messing	25
OS.69510	95 mm ²	M10	Vertind messing	25
OS.69513	95 mm ²	M13	Vertind messing	25
Blister verpakking				
HF.061006	10 mm ²	M6	Vertind messing	5
HF.061008	10 mm ²	M8	Vertind messing	5
HF.061606	16 mm ²	M6	Vertind messing	5
HF.061608	16 mm ²	M8	Vertind messing	5
HF.062506	25 mm ²	M6	Vertind messing	5
HF.062508	25 mm ²	M8	Vertind messing	5
HF.062510	25 mm ²	M10	Vertind messing	5
HF.063506	35 mm ²	M6	Vertind messing	5
HF.063508	35 mm ²	M8	Vertind messing	5
HF.063510	35 mm ²	M10	Vertind messing	5
HF.065008	50 mm ²	M8	Vertind messing	5
HF.065010	50 mm ²	M10	Vertind messing	5
HF.067008	70 mm ²	M8	Vertind messing	5
HF.067010	70 mm ²	M10	Vertind messing	5
HF.067013	70 mm ²	M13	Vertind messing	5
Artikelnummer	Beschrijving			
Doos verpakking				
MP.500390	Rode kap voor buiskabelschoenen			25
MP.500400	Zwarte kap voor buiskabelschoenen			25

OOG SOLDEER- / KRIMPKABELSCHOENEN

10-70mm²



Artikelnummer	⊙	⊕	Opmerkingen	📦
Doos verpakking				
0S.91006	10 mm ²	M6	Vertind messing	25
0S.91008	10 mm ²	M8	Vertind messing	25
0S.91606	16 mm ²	M6	Vertind messing	25
0S.91608	16 mm ²	M8	Vertind messing	25
0S.92506	25 mm ²	M6	Vertind messing	25
0S.92508	25 mm ²	M8	Vertind messing	25
0S.92510	25 mm ²	M10	Vertind messing	25
0S.93508	35 mm ²	M8	Vertind messing	25
0S.93510	35 mm ²	M10	Vertind messing	25
0S.95008	50 mm ²	M8	Vertind messing	25
0S.95010	50 mm ²	M10	Vertind messing	25
0S.95013	50 mm ²	M13	Vertind messing	25
0S.97010	70 mm ²	M10	Vertind messing	25
0S.97013	70 mm ²	M13	Vertind messing	25

KRIMPKABELVERBINDINGSMOFFEN

16-70mm²



Artikelnummer	⊕	⊙	Opmerkingen	📦
Doos verpakking				
0S.81600	26.2mm	16 mm ²	Vertind messing	25
0S.82500	30.5mm	25 mm ²	Vertind messing	25
0S.83500	30.5mm	35 mm ²	Vertind messing	25
0S.85000	35.5mm	50 mm ²	Vertind messing	25
0S.87000	35.5mm	70 mm ²	Vertind messing	25

OOGKABELSCHOENEN

M3 tot M10 - Kabelschoenen met dubbele klem

























Artikelnummer			Opmerkingen	
Zak verpakking				
VR.0633		0,5 - 1,0 mm ²	M3	1000
VR.0634		0,5 - 1,0 mm ²	M4	1000
VR.0635		0,5 - 1,0 mm ²	M5	1000
VR.0636		0,5 - 1,0 mm ²	M6	1000
VR.0638		0,5 - 1,0 mm ²	M8	1000
VR.0653		1,0 - 2,5 mm ²	M3	1000
VR.0654		1,0 - 2,5 mm ²	M4	1000
VR.0655		1,0 - 2,5 mm ²	M5	1000
VR.0656		1,0 - 2,5 mm ²	M6	1000
VR.0658		1,0 - 2,5 mm ²	M8	1000
VR.0660		1,0 - 2,5 mm ²	M10	1000
VR.0674		4,0 - 6,0 mm ²	M4	1000
VR.0675		4,0 - 6,0 mm ²	M5	1000
VR.0676		4,0 - 6,0 mm ²	M6	1000
VR.0678		4,0 - 6,0 mm ²	M8	1000
VR.0680		4,0 - 6,0 mm ²	M10	1000
Doos verpakking				
US.0633		0,5 - 1,0 mm ²	M3	100
US.0634		0,5 - 1,0 mm ²	M4	100
US.0635		0,5 - 1,0 mm ²	M5	100
US.0636		0,5 - 1,0 mm ²	M6	100
US.0638		0,5 - 1,0 mm ²	M8	100
US.0653		1,0 - 2,5 mm ²	M3	100
US.0654		1,0 - 2,5 mm ²	M4	100
US.0655		1,0 - 2,5 mm ²	M5	100
US.0656		1,0 - 2,5 mm ²	M6	100
US.0658		1,0 - 2,5 mm ²	M8	100
US.0660		1,0 - 2,5 mm ²	M10	100
US.0674		4,0 - 6,0 mm ²	M4	100
US.0675		4,0 - 6,0 mm ²	M5	100
US.0676		4,0 - 6,0 mm ²	M6	100
US.0678		4,0 - 6,0 mm ²	M8	100
US.0680		4,0 - 6,0 mm ²	M10	100
Blister verpakking				
HF.010634		0,5 - 1,0 mm ²	M4	10
HF.010635		0,5 - 1,0 mm ²	M5	10
HF.010636		0,5 - 1,0 mm ²	M6	10
HF.010655		1,0 - 2,5 mm ²	M5	10
HF.010656		1,0 - 2,5 mm ²	M6	10
HF.010658		1,0 - 2,5 mm ²	M8	10
HF.000676		4,0 - 6,0 mm ²	M6	10
HF.000678		4,0 - 6,0 mm ²	M8	10
HF.000680		4,0 - 6,0 mm ²	M10	10

MANNELIJKE PLATTE KABELSCHOENEN

2,8 tot 6,3mm - Kabelschoenen met dubbele klem



Artikelnummer			Opmerkingen	
Zak verpakking				
VR.0519		2.8 x 0.5mm	0,5 - 1,0 mm ²	1000
VR.0510		4.8 x 0.8mm	0,5 - 1,0 mm ²	1000
VR.0540		6.3 x 0.8mm	0,5 - 1,0 mm ²	1000
VR.0619		2.8 x 0.5mm	1,0 - 2,5 mm ²	1000
VR.0520		4.8 x 0.8mm	1,0 - 2,5 mm ²	1000
VR.0740		6.3 x 0.8mm	1,0 - 2,5 mm ²	1000
VR.0840		6.3 x 0.8mm	4,0 - 6,0 mm ²	1000
Doos verpakking				
US.0519		2.8 x 0.5mm	0,5 - 1,0 mm ²	100
US.0510		4.8 x 0.8mm	0,5 - 1,0 mm ²	100
US.0540		6.3 x 0.8mm	0,5 - 1,0 mm ²	100
US.0619		2.8 x 0.5mm	1,0 - 2,5 mm ²	100
US.0520		4.8 x 0.8mm	1,0 - 2,5 mm ²	100
US.0740		6.3 x 0.8mm	1,0 - 2,5 mm ²	100
US.0840		6.3 x 0.8mm	4,0 - 6,0 mm ²	100
Blister verpakking				
HF.010519		2.8 x 0.5mm	0,5 - 1,0 mm ²	10
HF.010510		4.8 x 0.8mm	0,5 - 1,0 mm ²	10
HF.010540		6.3 x 0.8mm	0,5 - 1,0 mm ²	10
HF.010520		4.8 x 0.8mm	1,0 - 2,5 mm ²	10
HF.010740		6.3 x 0.8mm	1,0 - 2,5 mm ²	10
HF.010840		6.3 x 0.8mm	4,0 - 6,0 mm ²	10

VROUWELIJKE PLATTE KABELSCHOENEN

2,8 tot 9,5mm - Kabelschoenen met dubbele klem



Artikelnummer			Opmerkingen	
Zak verpakking				
VR.0559.5		2.8 x 0.5mm	0,5 - 1,0 mm ²	1000
VR.0559.8		2.8 x 0.8mm	0,5 - 1,0 mm ²	1000
VR.0741.5		4.8 x 0.5mm	0,5 - 1,0 mm ²	1000
VR.0741.8		4.8 x 0.8mm	0,5 - 1,0 mm ²	1000
VR.0541		6.3 x 0.8mm	0,5 - 1,0 mm ²	1000
VR.0659.5		2.8 x 0.5mm	1,0 - 2,5 mm ²	1000
VR.0659.8		2.8 x 0.8mm	1,0 - 2,5 mm ²	1000
VR.0742.5		4.8 x 0.5mm	1,0 - 2,5 mm ²	1000
VR.0742.8		4.8 x 0.8mm	1,0 - 2,5 mm ²	1000
VR.0542		6.3 x 0.8mm	1,0 - 2,5 mm ²	1000
VR.0544		8.0 x 0.8mm	1,0 - 2,5 mm ²	1000
VR.0543		6.3 x 0.8mm	4,0 - 6,0 mm ²	1000
VR.0555		9.5 x 1.1mm	4,0 - 6,0 mm ²	1000
Doos verpakking				
US.0559.5		2.8 x 0.5mm	0,5 - 1,0 mm ²	100
US.0559.8		2.8 x 0.8mm	0,5 - 1,0 mm ²	100
US.0741.5		4.8 x 0.5mm	0,5 - 1,0 mm ²	100
US.0741.8		4.8 x 0.8mm	0,5 - 1,0 mm ²	100
US.0541		6.3 x 0.8mm	0,5 - 1,0 mm ²	100
US.0659.5		2.8 x 0.5mm	1,0 - 2,5 mm ²	100
US.0659.8		2.8 x 0.8mm	1,0 - 2,5 mm ²	100
US.0742.5		4.8 x 0.5mm	1,0 - 2,5 mm ²	100
US.0742.8		4.8 x 0.8mm	1,0 - 2,5 mm ²	100
US.0542		6.3 x 0.8mm	1,0 - 2,5 mm ²	100
US.0544		8.0 x 0.8mm	1,0 - 2,5 mm ²	100
US.0543		6.3 x 0.8mm	4,0 - 6,0 mm ²	100
US.0555		9.5 x 1.1mm	4,0 - 6,0 mm ²	100
Blister verpakking				
HF.015595		2.8 x 0.5mm	0,5 - 1,0 mm ²	10
HF.017418		4.8 x 0.8mm	0,5 - 1,0 mm ²	10
HF.010541		6.3 x 0.8mm	0,5 - 1,0 mm ²	10
HF.016595		2.8 x 0.5mm	1,0 - 2,5 mm ²	10
HF.010542		6.3 x 0.8mm	1,0 - 2,5 mm ²	10
HF.010544		8.0 x 0.8mm	1,0 - 2,5 mm ²	10
HF.010543		6.3 x 0.8mm	4,0 - 6,0 mm ²	10

100% GEÏSOLEERDE VROUWELIJKE PLATTE KABELSCHOENEN

2,8 tot 9,5mm - Kabelschoenen met dubbele klem



Artikelnummer			Opmerkingen	
Zak verpakking				
VR.2559		2.8 x 0.5mm	0,5 - 1,0 mm ²	Nylon 1000
VR.2741		4.8 x 0.5mm	0,5 - 1,0 mm ²	Nylon 1000
VR.2541		6.3 x 0.8mm	0,5 - 1,0 mm ²	Nylon 1000
VR.2659		2.8 x 0.5mm	1,0 - 2,5 mm ²	Nylon 1000
VR.2742		4.8 x 0.5mm	1,0 - 2,5 mm ²	Nylon 1000
VR.2542		6.3 x 0.8mm	1,0 - 2,5 mm ²	Nylon 1000
VR.2543		6.3 x 0.8mm	4,0 - 6,0 mm ²	Nylon 1000
Doos verpakking				
US.2559		2.8 x 0.5mm	0,5 - 1,0 mm ²	Nylon 100
US.2741		4.8 x 0.5mm	0,5 - 1,0 mm ²	Nylon 100
US.2541		6.3 x 0.8mm	0,5 - 1,0 mm ²	Nylon 100
US.2659		2.8 x 0.5mm	1,0 - 2,5 mm ²	Nylon 100
US.2742		4.8 x 0.5mm	1,0 - 2,5 mm ²	Nylon 100
US.2542		6.3 x 0.8mm	1,0 - 2,5 mm ²	Nylon 100
US.0905		6.3 x 0.8mm	1,0 - 2,5 mm ²	"Vlag" kabelschoen 100
US.2543		6.3 x 0.8mm	4,0 - 6,0 mm ²	Nylon 100
US.2555		9.5 x 1.1mm	4,0 - 6,0 mm ²	Vinyl 100
Blister verpakking				
HF.012541		6.3 x 0.8mm	0,5 - 1,0 mm ²	Nylon 10
HF.012742		4.8 x 0.5mm	1,0 - 2,5 mm ²	Nylon 10
HF.012542		6.3 x 0.8mm	1,0 - 2,5 mm ²	Nylon 10
HF.012543		6.3 x 0.8mm	4,0 - 6,0 mm ²	Nylon 10

MANNELIJKE CILINDERKABELSCHOENEN

M4 / M5 - Kabelschoenen met dubbele klem



Artikelnummer			Opmerkingen	
Zak verpakking				
VR.0547		0,5 - 1,0 mm ²	M4	1000
VR.0550.4		1,0 - 2,5 mm ²	M4	1000
VR.0550.5		1,0 - 2,5 mm ²	M5	1000
VR.0850		4,0 - 6,0 mm ²	M5	1000
Doos verpakking				
US.0547		0,5 - 1,0 mm ²	M4	100
US.0550.4		1,0 - 2,5 mm ²	M4	100
US.0550.5		1,0 - 2,5 mm ²	M5	100
US.0850		4,0 - 6,0 mm ²	M5	100
Blister verpakking				
HF.010547		0,5 - 1,0 mm ²	M4	10
HF.015504		1,0 - 2,5 mm ²	M4	10
HF.015505		1,0 - 2,5 mm ²	M5	10
HF.010850		4,0 - 6,0 mm ²	M5	10

MANNELIJKE CILINDERKABELSCHOENEN - NYLON

M4 / M5 - Kabelschoenen met dubbele klem



Artikelnummer			Opmerkingen	
Zak verpakking				
VR.2547		0,5 - 1,0 mm ²	M4	1000
VR.2550.4		1,0 - 2,5 mm ²	M4	1000
VR.2550.5		1,0 - 2,5 mm ²	M5	1000
Doos verpakking				
US.2547		0,5 - 1,0 mm ²	M4	100
US.2550.4		1,0 - 2,5 mm ²	M4	100
US.2550.5		1,0 - 2,5 mm ²	M5	100

VROUWELIJKE CILINDERKABELSCHOENEN

M4 / M5 - Kabelschoenen met dubbele klem



Artikelnummer			Opmerkingen	
Zak verpakking				
VR.0548		0,5 - 1,0 mm ²	M4	1000
VR.0549.4		1,0 - 2,5 mm ²	M4	1000
VR.0549.5		1,0 - 2,5 mm ²	M5	1000
VR.0849		4,0 - 6,0 mm ²	M5	1000
Doos verpakking				
US.0548		0,5 - 1,0 mm ²	M4	100
US.0549.4		1,0 - 2,5 mm ²	M4	100
US.0549.5		1,0 - 2,5 mm ²	M5	100
US.0849		4,0 - 6,0 mm ²	M5	100
Blister verpakking				
HF.010548		0,5 - 1,0 mm ²	M4	10
HF.015494		1,0 - 2,5 mm ²	M4	10
HF.015495		1,0 - 2,5 mm ²	M5	10
HF.010849		4,0 - 6,0 mm ²	M5	10

VROUWELIJKE CILINDERKABELSCHOENEN - NYLON

M4 / M5 - Kabelschoenen met dubbele klem



Artikelnummer			Opmerkingen	
Zak verpakking				
VR.2548		0,5 - 1,0 mm ²	M4	1000
VR.2549.4		1,0 - 2,5 mm ²	M4	1000
VR.2549.5		1,0 - 2,5 mm ²	M5	1000
Doos verpakking				
US.2548		0,5 - 1,0 mm ²	M4	100
US.2549.4		1,0 - 2,5 mm ²	M4	100
US.2549.5		1,0 - 2,5 mm ²	M5	100

VERBINDINGSHULZEN - VINYL



Artikelnummer		Opmerkingen	
Zak verpakking			
VR.0545		0,5 - 1,0 mm ²	1000
VR.0546		1,0 - 2,5 mm ²	1000
VR.0551		4,0 - 6,0 mm ²	1000
Doos verpakking			
US.0545		0,5 - 1,0 mm ²	100
US.0546		1,0 - 2,5 mm ²	100
US.0551		4,0 - 6,0 mm ²	100
Blister verpakking			
HF.010545		0,5 - 1,0 mm ²	10
HF.010546		1,0 - 2,5 mm ²	10
HF.010551		4,0 - 6,0 mm ²	10

VERBINDINGSHULZEN - NYLON



Artikelnummer		Opmerkingen	
Zak verpakking			
VR.0701		0,5 - 1,0 mm ²	1000
VR.0702		1,0 - 2,5 mm ²	1000
VR.0703		4,0 - 6,0 mm ²	1000
Doos verpakking			
US.0701		0,5 - 1,0 mm ²	100
US.0702		1,0 - 2,5 mm ²	100
US.0703		4,0 - 6,0 mm ²	100

VORKKABELSCHOENEN

M3 tot M6 - Kabelschoenen met dubbele klem







Artikelnummer			Opmerkingen	
Zak verpakking				
VR.0644		0,5 - 1,0 mm ²	M4	1000
VR.0663		1,0 - 2,5 mm ²	M3	1000
VR.0664		1,0 - 2,5 mm ²	M4	1000
VR.0665		1,0 - 2,5 mm ²	M5	1000
VR.0666		1,0 - 2,5 mm ²	M6	1000
VR.0685		4,0 - 6,0 mm ²	M5	1000
Doos verpakking				
US.0644		0,5 - 1,0 mm ²	M4	100
US.0663		1,0 - 2,5 mm ²	M3	100
US.0664		1,0 - 2,5 mm ²	M4	100
US.0665		1,0 - 2,5 mm ²	M5	100
US.0666		1,0 - 2,5 mm ²	M6	100
US.0685		4,0 - 6,0 mm ²	M5	100

TWEESLACHTIGE KLEMMEN

Kabelschoenen met dubbele klem









Artikelnummer			Opmerkingen	
Zak verpakking				
VR.0561		6.3 x 0.8mm	0,5 - 1,0 mm ²	1000
VR.0562		6.3 x 0.8mm	1,0 - 2,5 mm ²	1000
Doos verpakking				
US.0561		6.3 x 0.8mm	0,5 - 1,0 mm ²	100
US.0562		6.3 x 0.8mm	1,0 - 2,5 mm ²	100
Blister verpakking				
HF.010562		6.3 x 0.8mm	1,0 - 2,5 mm ²	10

EINDSTUKJES

Kabelschoenen met dubbele klem



Artikelnummer			Opmerkingen	
Zak verpakking				
VR.0566		1.9 x 12mm	0,5 - 1,0 mm ²	1000
VR.0621		1.9 x 12mm	1,0 - 2,5 mm ²	1000
VR.0622		2.7 x 14mm	4,0 - 6,0 mm ²	1000
Doos verpakking				
US.0566		1.9 x 12mm	0,5 - 1,0 mm ²	100
US.0621		1.9 x 12mm	1,0 - 2,5 mm ²	100
US.0622		2.7 x 14mm	4,0 - 6,0 mm ²	100

OOGKRIMPKABELSCHOENEN

M4 tot M10



Artikelnummer			Opmerkingen	
Zak verpakking				
VR.0634T		0,5 - 1,0 mm ²	M4	500
VR.0635T		0,5 - 1,0 mm ²	M5	500
VR.0636T		0,5 - 1,0 mm ²	M6	500
VR.0654T		1,0 - 2,5 mm ²	M4	500
VR.0655T		1,0 - 2,5 mm ²	M5	500
VR.0656T		1,0 - 2,5 mm ²	M6	500
VR.0658T		1,0 - 2,5 mm ²	M8	500
VR.0675T		4,0 - 6,0 mm ²	M5	500
VR.0676T		4,0 - 6,0 mm ²	M6	500
VR.0678T		4,0 - 6,0 mm ²	M8	500
VR.0680T		4,0 - 6,0 mm ²	M10	500
Doos verpakking				
US.0634T		0,5 - 1,0 mm ²	M4	50
US.0635T		0,5 - 1,0 mm ²	M5	50
US.0636T		0,5 - 1,0 mm ²	M6	50
US.0654T		1,0 - 2,5 mm ²	M4	50
US.0655T		1,0 - 2,5 mm ²	M5	50
US.0656T		1,0 - 2,5 mm ²	M6	50
US.0658T		1,0 - 2,5 mm ²	M8	50
US.0675T		4,0 - 6,0 mm ²	M5	50
US.0676T		4,0 - 6,0 mm ²	M6	50
US.0678T		4,0 - 6,0 mm ²	M8	50
US.0680T		4,0 - 6,0 mm ²	M10	50
Blister verpakking				
HF.010634T		0,5 - 1,0 mm ²	M4	10
HF.010635T		0,5 - 1,0 mm ²	M5	10
HF.010636T		0,5 - 1,0 mm ²	M6	10
HF.010654T		1,0 - 2,5 mm ²	M4	10
HF.010655T		1,0 - 2,5 mm ²	M5	10
HF.010656T		1,0 - 2,5 mm ²	M6	10
HF.010658T		1,0 - 2,5 mm ²	M8	10
HF.010675T		4,0 - 6,0 mm ²	M5	10
HF.010676T		4,0 - 6,0 mm ²	M6	10
HF.010678T		4,0 - 6,0 mm ²	M8	10
HF.010680T		4,0 - 6,0 mm ²	M10	10

Omgevingstemperatuur: -55°C ~ 125°C

Krimptemperatuur: 80°C

Ratio 3:1

Waterdicht IP68

Roestbestendig en slijtvast

PLATTE MANNELIJKE KRIMPKABELSCHOENEN

6,35mm



Artikelnummer		L	Ø	Opmerkingen	
Zak verpakking					
VR.0540T		6.35 mm	0,5 - 1,0 mm ²		500
VR.0740T		6.35 mm	1,0 - 2,5 mm ²		500
VR.0840T		6.35 mm	4,0 - 6,0 mm ²		500
Doos verpakking					
US.0540T		6.35 mm	0,5 - 1,0 mm ²		50
US.0740T		6.35 mm	1,0 - 2,5 mm ²		50
US.0840T		6.35 mm	4,0 - 6,0 mm ²		50
Blister verpakking					
HF.010540T		6.35 mm	0,5 - 1,0 mm ²		10
HF.010740T		6.35 mm	1,0 - 2,5 mm ²		10
HF.010840T		6.35 mm	4,0 - 6,0 mm ²		10

Omgevingstemperatuur: -55°C ~ 125°C

Krimptemperatuur: 80°C

Ratio 3:1

Waterdicht IP68

Roestbestendig en slijtvast

PLATTE VROUWELIJKE KRIMPKABELSCHOENEN

6,35mm



Artikelnummer		L	Ø	Opmerkingen	
Zak verpakking					
VR.0541T		6.35 mm	0,5 - 1,0 mm ²		500
VR.0542T		6.35 mm	1,0 - 2,5 mm ²		500
VR.0543T		6.35 mm	4,0 - 6,0 mm ²		500
Doos verpakking					
US.0541T		6.35 mm	0,5 - 1,0 mm ²		50
US.0542T		6.35 mm	1,0 - 2,5 mm ²		50
US.0543T		6.35 mm	4,0 - 6,0 mm ²		50
Blister verpakking					
HF.010541T		6.35 mm	0,5 - 1,0 mm ²		10
HF.010542T		6.35 mm	1,0 - 2,5 mm ²		10
HF.010543T		6.35 mm	4,0 - 6,0 mm ²		10

Omgevingstemperatuur: -55°C ~ 125°C

Krimptemperatuur: 80°C

Ratio 3:1

Waterdicht IP68

Roestbestendig en slijtvast

100% GEÏSOLEERDE PLATTE VROUWELIJKE KRIMPKABELSCHOENEN

6,35mm



Artikelnummer		L	Ø	Opmerkingen	
Zak verpakking					
VR.2541T		6.35 mm	0,5 - 1,0 mm ²		500
VR.2542T		6.35 mm	1,0 - 2,5 mm ²		500
VR.2543T		6.35 mm	4,0 - 6,0 mm ²		500
Doos verpakking					
US.2541T		6.35 mm	0,5 - 1,0 mm ²		50
US.2542T		6.35 mm	1,0 - 2,5 mm ²		50
US.2543T		6.35 mm	4,0 - 6,0 mm ²		50
Blister verpakking					
HF.012541T		6.35 mm	0,5 - 1,0 mm ²		10
HF.012542T		6.35 mm	1,0 - 2,5 mm ²		10
HF.012543T		6.35 mm	4,0 - 6,0 mm ²		10

Omgevingstemperatuur: -55°C ~ 125°C

Krimptemperatuur: 80°C

Ratio 3:1

Waterdicht IP68

Roestbestendig en slijtvast

100% GEÏSOLEERDE PLATTE MANNELIJKE KRIMPKABELSCHOENEN

6,35mm



Artikelnummer		L	Ø	Opmerkingen	
Zak verpakking					
VR.2540T		6.35 mm	0,5 - 1,0 mm ²		500
VR.2740T		6.35 mm	1,0 - 2,5 mm ²		500
VR.2840T		6.35 mm	4,0 - 6,0 mm ²		500
Doos verpakking					
US.2540T		6.35 mm	0,5 - 1,0 mm ²		50
US.2740T		6.35 mm	1,0 - 2,5 mm ²		50
US.2840T		6.35 mm	4,0 - 6,0 mm ²		50
Blister verpakking					
HF.012540T		6.35 mm	0,5 - 1,0 mm ²		10
HF.012740T		6.35 mm	1,0 - 2,5 mm ²		10
HF.012840T		6.35 mm	4,0 - 6,0 mm ²		10

Omgevingstemperatuur: -55°C ~ 125°C

Krimptemperatuur: 80°C

Ratio 3:1

Waterdicht IP68

Roestbestendig en slijtvast

MANNELIJKE CILINDERKRIMPKABELSCHOENEN

M4 / M5



Artikelnummer			Opmerkingen	
Zak verpakking				
VR.0547T		0,5 - 1,0 mm ²	M4	500
VR.0550.4T		1,0 - 2,5 mm ²	M4	500
VR.0550.5T		1,0 - 2,5 mm ²	M5	500
Doos verpakking				
US.0547T		0,5 - 1,0 mm ²	M4	50
US.0550.4T		1,0 - 2,5 mm ²	M4	50
US.0550.5T		1,0 - 2,5 mm ²	M5	50
Blister verpakking				
HF.010547T		0,5 - 1,0 mm ²	M4	10
HF.015504T		1,0 - 2,5 mm ²	M5	10
HF.015505T		1,0 - 2,5 mm ²	M5	10

Omgevingstemperatuur: -55°C ~ 125°C

Krimptemperatuur: 80°C

Ratio 3:1

Waterdicht IP68

Roestbestendig en slijtvast

VROUWELIJKE CILINDERKRIMPKABELSCHOENEN

M4 / M5



Artikelnummer		Opmerkingen	
Zak verpakking			
VR.0548T		M4	500
VR.0549.4T		M4	500
VR.0549.5T		M5	500
Doos verpakking			
US.0548T		M4	50
US.0549.4T		M4	50
US.0549.5T		M5	50
Blister verpakking			
HF.010548T		M4	10
HF.015494T		M4	10
HF.015495T		M5	10

Omgevingstemperatuur: -55°C ~ 125°C

Krimptemperatuur: 80°C

Ratio 3:1

Waterdicht IP68

Roestbestendig en slijtvast

VORKKRIMPKABELSCHOENEN

M4 / M5



Artikelnummer			Opmerkingen	
Zak verpakking				
VR.0644T		0,5 - 1,0 mm ²	M4	500
VR.0665T		1,0 - 2,5 mm ²	M5	500
VR.0685T		4,0 - 6,0 mm ²	M5	500
Doos verpakking				
US.0644T		0,5 - 1,0 mm ²	M4	50
US.0665T		1,0 - 2,5 mm ²	M5	50
US.0685T		4,0 - 6,0 mm ²	M5	50

Omgevingstemperatuur: -55°C ~ 125°C

Krimptemperatuur: 80°C









Ratio 3:1

Waterdicht IP68

Roestbestendig en slijtvast

KRIMPVERBINDINGSHULZEN



Artikelnummer		Opmerkingen	
Zak verpakking			
VR.0545T	 0,5 - 1,0 mm ²		500
VR.0546T	 1,0 - 2,5 mm ²		500
VR.0551T	 4,0 - 6,0 mm ²		500
Doos verpakking			
US.0545T	 0,5 - 1,0 mm ²		50
US.0546T	 1,0 - 2,5 mm ²		50
US.0551T	 4,0 - 6,0 mm ²		50
Blister verpakking			
HF.010545T	 0,5 - 1,0 mm ²		10
HF.010546T	 1,0 - 2,5 mm ²		10
HF.010551T	 4,0 - 6,0 mm ²		10

Omgevingstemperatuur: -55°C ~ 125°C

Krimptemperatuur: 80°C

Ratio 3:1

Waterdicht IP68

Roestbestendig en slijtvast

SOLDEER KRIMPVERBINDINGSHULZEN



Artikelnummer			Opmerkingen	
Zak verpakking				
VR.2241TS	 dia. 1.7mm	0.1 - 0.5		500
VR.2341TS	 dia. 2.7mm	0.5 - 1.0		500
VR.2251TS	 dia. 4.5mm	1.0 - 2.5		500
VR.2261TS	 dia. 6.0mm	2.5 - 6.0		500
Doos verpakking				
US.2241TS	 dia. 1.7mm	0.1 - 0.5		25
US.2341TS	 dia. 2.7mm	0.5 - 1.0		25
US.2251TS	 dia. 4.5mm	1.0 - 2.5		25
US.2261TS	 dia. 6.0mm	2.5 - 6.0		25

Omgevingstemperatuur: -55°C ~ 105°C

Krimptemperatuur: 60°C







Ratio 2:1

Waterdicht IP68

Transparante huls

ZELFSTRIPPENDE CONNECTOREN



Artikelnummer		Opmerkingen	
Zak verpakking			
VR.2568	 0,5 - 1,0 mm ²		1000
VR.2569	 1,0 - 2,5 mm ²		1000
Zakje verpakking			
US.2568	 0,5 - 1,0 mm ²		100
US.2569	 1,0 - 2,5 mm ²		100
US.2571	 4,0 - 6,0 mm ²		50
Blister verpakking			
HF.002568	 0,5 - 1,0 mm ²		10
HF.002569	 1,0 - 2,5 mm ²		10

ZELFSTRIPPENDE CONNECTOREN T-TAP



Artikelnummer			♀	Opmerkingen	
Zak verpakking					
VR.2951			0,5 - 1,0 mm ²	F	500
VR.2540		6.3 x 0.8mm ²	0,5 - 1,0 mm ²	M	1000
VR.2952			1,0 - 2,5 mm ²	F	500
VR.2740		6.3 x 0.8mm ²	1,0 - 2,5 mm ²	M	1000
VR.2953			4,0 - 6,0 mm ²	F	500
VR.2840		6.3 x 0.8mm ²	4,0 - 6,0 mm ²	M	1000
Doos verpakking					
US.2951			0,5 - 1,0 mm ²	F	100
US.2540		6.3 x 0.8mm ²	0,5 - 1,0 mm ²	M	100
US.2952			1,0 - 2,5 mm ²	F	100
US.2740		6.3 x 0.8mm ²	1,0 - 2,5 mm ²	M	100
US.2953			4,0 - 6,0 mm ²	F	100
US.2840		6.3 x 0.8mm ²	4,0 - 6,0 mm ²	M	100
Blister verpakking					
HF.002951			0,5 - 1,0 mm ²		10
HF.002952			1,0 - 2,5 mm ²		10
HF.002953			4,0 - 6,0 mm ²		10

DUBBEL GEÏSOLEERDE MANNELIJKE KOPPELINGEN



Artikelnummer	Beschrijving	
Doos verpakking		
OS.02690	Dubbel geïsoleerde koppeling voor 2 vrouwelijke platte kabelschoenen 6,35mm	25

Y-VERBINDER - PLATTE KABELSCHOENEN

6,3mm



Artikelnummer	Beschrijving	
Doos verpakking		
OS.02590	2 mannelijke / 1 vrouwelijke	25
OS.02591	2 vrouwelijke / 1 mannelijke	25
Blister verpakking		
HF.602590	2 mannelijke / 1 vrouwelijke	2
HF.602591	2 vrouwelijke / 1 mannelijke	2

Y-VERBINDER - CILINDERKABELSCHOENEN

M4



Artikelnummer	Beschrijving	
Doos verpakking		
OS.02592	2 mannelijke / 1 vrouwelijke	25
OS.02593	2 vrouwelijke / 1 mannelijke	25

KABELEINDSTUKKEN

Franse kleurcode



Artikelnummer			Opmerkingen	
Doos verpakking				
05.02007		8.00 mm	0.75 mm ²	100
05.02010		8.00 mm	1.00 mm ²	100
05.02015		8.00 mm	1.50 mm ²	100
05.02025		8.00 mm	2.50 mm ²	100
05.02040		12.00 mm	4.00 mm ²	100
05.02060		12.00 mm	6.00 mm ²	100
05.02100		12.00 mm	10.00 mm ²	100
05.02160		12.00 mm	16.00 mm ²	100
05.02250		16.00 mm	25.00 mm ²	100

SET MET KABELEINDSTUKKEN (100 STK)



Artikelnummer	Inhoud	
Doos verpakking		
05.03100	Kabeleindstukken (100): 50x 4,00mm ² geel 20x 6,00mm ² groen 20x 10,00mm ² bruin 10x 16,00mm ² wit	1



SET MET KABELEINDSTUKKEN (400 STK)



Artikelnummer	Inhoud	
Doos verpakking		
05.03400	Kabeleindstukken (400): 100x 0,75mm ² blauw 100x 1,00mm ² rood 100x 1,50mm ² zwart 100x 2,50mm ² grijs	1

KABELVERBINDERS



Artikelnummer			Opmerkingen	
Zak verpakking				
05.01601		Dia.: 2.4mm	0.5 - 1.0mm ²	100
05.01602		Dia.: 3.0mm	1.5 - 2.5mm ²	100
05.01603		Dia.: 3.8mm	4.0 - 6.0mm ²	100

GEMENGDE BLISTERS MET ELEKTRISCHE KABELSCHOENEN



Artikelnummer	Inhoud	
Blister verpakking		
HF.002580	Mannelijke platte kabelschoenen 6.3mm: 10x blauw Vrouwelijke platte kabelschoenen 6.3mm: 10x blauw	1
HF.002581	Mannelijke platte kabelschoenen 6.3mm: 10x rood Vrouwelijke platte kabelschoenen 6.3mm: 10x rood	1
HF.002582	Mannelijke cilinderkabelschoenen M4: 10x blauw Vrouwelijke cilinderkabelschoenen M4: 10x blauw	1
HF.002583	Mannelijke cilinderkabelschoenen M4: 10x rood Vrouwelijke cilinderkabelschoenen M4: 10x rood	1
HF.002585	Oogkabelschoenen: 5x M4 blauw, 5x M5 blauw, 5x M6 blauw, 5x M8 blauw	1
HF.002586	100% geïsoleerde vrouwelijke platte kabelschoenen 6.3mm: 10x rood Mannelijke platte kabelschoenen 6.3mm: 10x rood	1
HF.002587	100% geïsoleerde vrouwelijke platte kabelschoenen 6.3mm: 10x blauw Mannelijke platte kabelschoenen 6.3mm: 10x blauw	1
HF.002588	Mannelijke cilinderkabelschoenen M5: 5x geel Vrouwelijke cilinderkabelschoenen M5: 5x geel	1
HF.002589	Hi-Fi Vrouwelijke platte kabelschoenen: 4x (2.8 x 0.5mm) rood, 4x (4.8 x 0.5mm) rood, 4x (6.3 x 0.5mm) blauw Mannelijke platte kabelschoenen: 4x (6.3 x 0.5mm) blauw Oogkabelschoenen: 2x M6 blauw, 2x M8 blauw	1
HF.002595	Zelfstrippende connector: 5x rood Mannelijke platte kabelschoenen voor zelfstrippende connector: 5x rood	1
HF.002596	Zelfstrippende connector: 5x blauw Mannelijke platte kabelschoenen voor zelfstrippende connector: 5x blauw	1

GEMENGDE BLISTER MET THERMISCHE KRIMPVERBINDINGHULZEN



Artikelnummer	Inhoud	
Blister verpakking		
HF.040040	Warmtekrimpde verbindingshulzen: 10x rood, 20x blauw, 10x geel	1

GEMENGDE BLISTER MET THERMISCHE SOLDEERVERBINDINGHULZEN



Artikelnummer	Inhoud	
Blister verpakking		
HF.040030	Verbindingshulzen: 5x transparant, 10x rood, 10x blauw, 5x geel	1

BLISTER MET GEÏSOLEERDE KABELSCHOENEN EN KRIMPTANG



Artikelnummer	Inhoud	
Blister verpakking		
ZB.3000	Geïsoleerde kabelschoenen (48): Platte mannelijke kabelschoenen: 3x rood, 3x blauw Platte vrouwelijke kabelschoenen: 3x rood, 3x blauw Vorkkabelschoenen: 3x M4 rood, 3x M5 rood, 3x M4 blauw, 3x M5 blauw Oogkabelschoenen: 3x M4 rood, 3x M5 rood, 3x M4 blauw, 3x M5 blauw Verbindingshulzen: 6x rood, 6x blauw Krimptang (EI.K034)	1

DOOS MET 100 KABELSCHOENEN



Artikelnummer	Inhoud	
Koffer verpakking		
ZB.4001	Mannelijke platte kabelschoenen 6,3mm: 5x rood, 7x blauw Vrouwelijke platte kabelschoenen 6,3mm: 5x rood, 10x blauw, 5x geel 100% geïsoleerde vrouwelijke platte kabelschoenen 6,3mm: 5x rood, 7x blauw, 5x geel Mannelijke cilinderkabelschoenen M4: 5x blauw Vrouwelijke cilinderkabelschoenen M4: 5x blauw Verbindingshulzen: 7x rood, 7x blauw, 5x geel Oogkabelschoenen: 5x M5 blauw, 5x M6 blauw, 5x M8 blauw, 5x M8 geel Splitsing: 2x blauw	1

DOOS MET 220 KABELSCHOENEN

Krimpkabelschoenen



Artikelnummer	Inhoud	
Koffer verpakking		
ZB.5702	Mannelijke platte kabelschoenen 6,3mm: 15x rood, 15x blauw, 10x geel Vrouwelijke platte kabelschoenen 6,3mm: 15x rood, 15x blauw, 10x geel Verbindingshulzen: 25x rood, 25x blauw, 10x geel Oogkabelschoenen: 10x M4 rood, 10x M5 rood, 10x M6 rood, 10x M5 blauw, 10x M6 blauw, 10x M8 blauw, 10x M6 geel, 10x M8 geel	1

DOOS MET 225 KABELSCHOENEN

Krimpkabelschoenen



Artikelnummer	Inhoud	
Koffer verpakking		
MA.227	100% geïsoleerde mannelijke platte kabelschoenen 6,3mm: 5x rood, 5x blauw 100% geïsoleerde vrouwelijke platte kabelschoenen 6,3mm: 10x rood, 10x blauw Verbindingshulzen: 50x rood, 60x blauw, 15x geel Oogkabelschoenen: 10x M4 blauw, 10x M5 blauw, 10x M6 blauw, 10x M8 blauw, 10x M5 geel, 10x M6 geel, 10x M8 geel Krimptang Gaspistool	1

DOOS MET 300 KABELSCHOENEN + TANG



Artikelnummer	Inhoud	
Koffer verpakking		
ZB.6000	Mannelijke platte kabelschoenen 6,3mm: 15x rood, 25x blauw Vrouwelijke platte kabelschoenen 6,3mm: 15x rood, 25x blauw 100% geïsoleerde platte vrouwelijke kabelschoenen 6,3mm: 15x rood, 20x blauw Platte vrouwelijke kabelschoenen 2,8mm: 15x rood Mannelijke cilinderkabelschoenen M4: 15x rood, 15x blauw Vrouwelijke cilinderkabelschoenen M4: 15x rood, 15x blauw Verbindingshulzen: 15x rood, 20x blauw Oogkabelschoenen: 15x M6 rood, 20x M5 blauw, 20x M6 blauw Splitsing: 5x blauw Gemengde klemmen 6,3mm: 15x blauw	1

DOOS MET 535 KABELSCHOENEN

Speciaal voor landbouw



Artikelnummer	Inhoud	
Koffer verpakking		
ZB.5535	Mannelijke platte kabelschoenen 6,3mm: 25x rood, 40x blauw Vrouwelijke platte kabelschoenen 6,3mm: 40x blauw, 25x geel 100% geïsoleerde vrouwelijke platte kabelschoenen 6,3mm: 25x rood, 40x blauw, 25x geel Mannelijke cilinderkabelschoenen M5: 30x blauw Vrouwelijke cilinderkabelschoenen M5: 30x blauw Verbindingshulzen: 25x rood, 40x blauw Oogkabelschoenen: 30x M5 blauw, 30x M6 blauw, 30x M8 blauw, 25x M8 geel, 30x M10 geel Splitsing: 15x blauw Gemengde klemmen 6,3mm: 30x blauw	1

DOOS MET 590 KABELSCHOENEN, TANG & 40 KABELKLEMMEN



Artikelnummer	Inhoud	
Koffer verpakking		
ZB.5000	Mannelijke platte kabelschoenen 6,3mm: 30x rood, 40x blauw Vrouwelijke platte kabelschoenen 6,3mm: 30x rood, 50x blauw 100% geïsoleerde vrouwelijke platte kabelschoenen 6,3mm: 30x rood, 30x blauw Vrouwelijke platte kabelschoenen 2,8mm: 30x rood Verbindingshulzen: 30x rood, 30x blauw Mannelijke cilinderkabelschoenen M4: 30x rood, 30x blauw Vrouwelijke cilinderkabelschoenen M4: 30x rood, 30x blauw Oogkabelschoenen M5: 25x rood, 30x blauw Vorkkabelschoenen M4: 30x M4 rood, 30x M5 blauw Gemengde klemmen 6,3mm: 20x blauw Splitsing: 10x blauw Witte kabelbinders: 20x (2,5x100mm), 20x (3,6x200mm)	1

DOOS MET 775 KABELSCHOENEN



Artikelnummer	Inhoud	
Koffer verpakking		
ZB.5775	Mannelijke platte kabelschoenen 6,3mm: 50x rood, 50x blauw Vrouwelijke platte kabelschoenen 6,3mm: 50x rood, 50x blauw, 50x geel 100% geïsoleerd vrouwelijke kabelschoenen 6,3mm: 25x rood, 25x blauw Vrouwelijke platte kabelschoenen 2,8mm: 50x rood Vrouwelijke platte kabelschoenen 6,3mm: 50x rood Oogkabelschoenen M5: 25x geel, 50x M4 rood, 50x M4 blauw, 50x M5 blauw Mannelijke cilinderkabelschoenen M4: 50x blauw Vrouwelijke cilinderkabelschoenen M4: 25x blauw Verbindingshulzen: 25x rood, 25x blauw Vorkkabelschoenen: 50x M5 blauw Gemengde klemmen 6,3mm: 25x blauw	1

AMP SUPERSEAL KOPPELINGEN 1,5MM

IP67 - Geleverd zonder kabelschoenen of afdichtingen

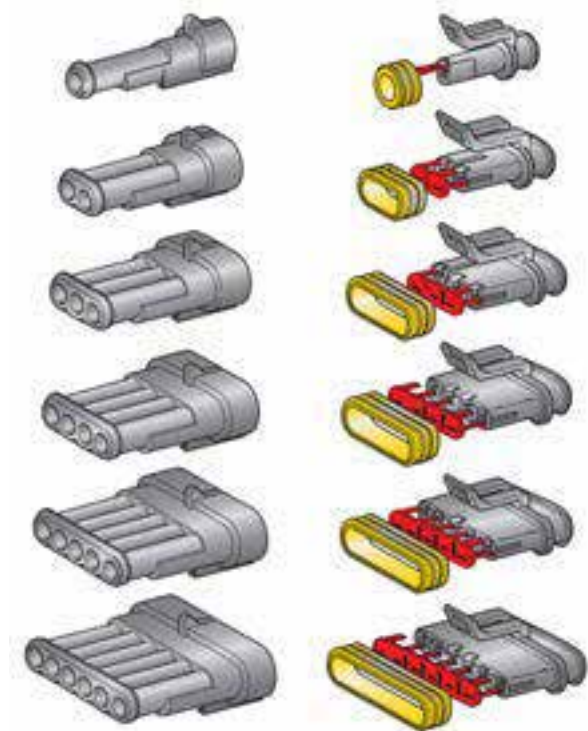

Artikelnummer	⏏	♀	↔	📦
Zakje verpakking				
OS.23610	1	F	OS.23620	10
OS.23620	1	M	OS.23610	10
OS.23630	2	F	OS.23640	10
OS.23640	2	M	OS.23630	10
OS.23650	3	F	OS.23660	10
OS.23660	3	M	OS.23650	10
OS.23670	4	F	OS.23680	5
OS.23680	4	M	OS.23670	5
OS.23690	5	F	OS.23700	5
OS.23700	5	M	OS.23690	5
OS.23710	6	F	OS.23720	5
OS.23720	6	M	OS.23710	5

Artikelnummer	Beschrijving	📦
Doos verpakking		
OS.07740	Waterdichte pakking	100
OS.07750	Waterdichte pakking	100

AMP SUPERSEAL KOPPELINGEN 2,8MM

IP67 - Geleverd zonder kabelschoenen of dichtingen

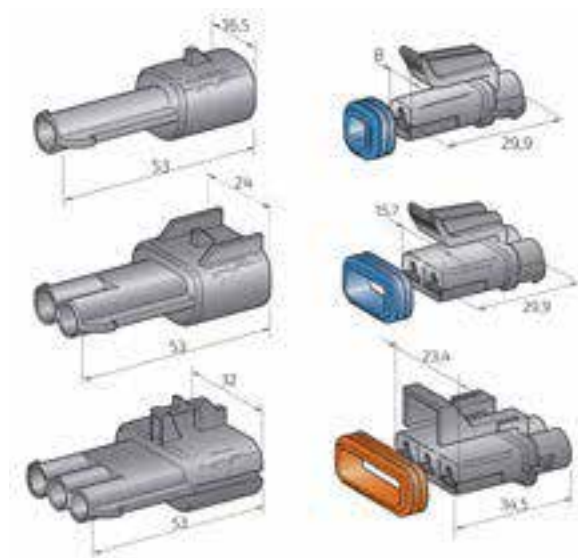

Artikelnummer	⏏	♀	↔	📦
Doos verpakking				
OS.23520	1	F	OS.23510	5
OS.23510	1	M	OS.23520	5
OS.23540	2	F	OS.23530	5
OS.23530	2	M	OS.23540	5
OS.23560	3	F	OS.23550	5
OS.23550	3	M	OS.23560	5

Artikelnummer	Beschrijving	📦
Doos verpakking		
OS.07510	Waterdichte pakking	100

KABELSCHOENEN VOOR AMP SUPERSEAL KOPPELINGEN

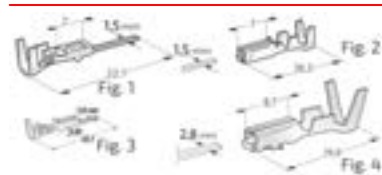

Artikelnummer	📏	⊙	♀	Opmerkingen	📦	📦
Doos verpakking						
OS.05550	1.5 x 0.32 mm	0.5 - 1.5 mm ²	M	Serie 1,5mm	1	100
OS.05560	1.5 x 0.3 mm	0.5 - 1.5 mm ²	F	Serie 1,5mm	2	100
OS.04500	2.8 x 0.4 mm	1.5 - 2.5 mm ²	M	Serie 2,8mm	3	50
OS.04510	2.8 x 0.4 mm	1.5 - 2.5 mm ²	F	Serie 2,8mm	4	100

STROOMAANSLUITINGEN

Geleverd zonder kabelschoenen

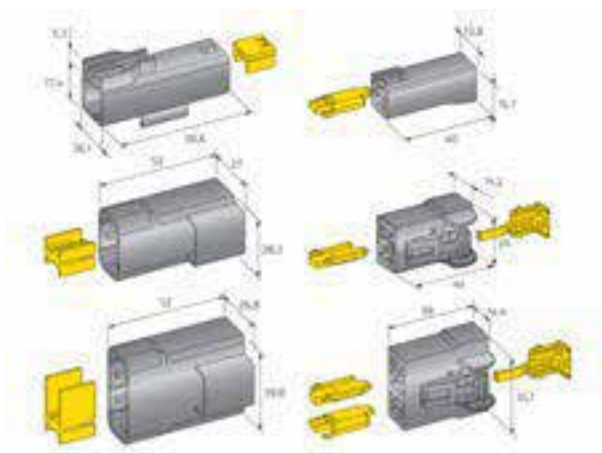

Artikelnummer	⏏	♀	↔	📦
Doos verpakking				
OS.40200	1	F	OS.40100	20
OS.40100	1	M	OS.40200	20
OS.40400	2	F	OS.40300	10
OS.40300	2	M	OS.40400	10
OS.40410	2	F	OS.40310	10
OS.40310	2	M	OS.40410	10
OS.40420	2	F	OS.40340	10
OS.40340	2	M	OS.40420	10
OS.40800	3	F	OS.40700	10
OS.40700	3	M	OS.40800	10

KABELSCHOENEN VOOR STROOMAANSLUITINGEN

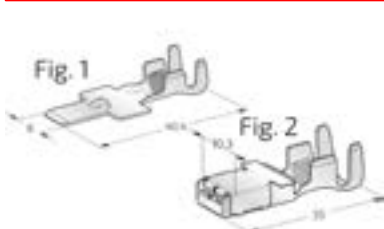

Artikelnummer	L	⊙	♀	Opmerkingen	📷	📦
Doos verpakking						
OS.07675	8.0 x 0.5 mm	2.5 - 4.0 mm ²	M		2	20
OS.07685	8.0 x 0.5 mm	6.0 - 8.0 mm ²	M		2	20
OS.07690	8.0 x 0.5 mm	10.0 - 16.0 mm ²	M		2	20
OS.07650	8.0 x 0.5 mm	1.5 - 2.5 mm ²	F		1	20
OS.07660	8.0 x 0.5 mm	4.0 - 6.0 mm ²	F		1	20
OS.07670	8.0 x 0.5 mm	8.0 - 10.0 mm ²	F		1	20
OS.07671	8.0 x 0.5 mm	16.0 mm ²	F		1	20

"MATE-N-LOK" KOPPELINGEN

Geleverd zonder kabelschoenen

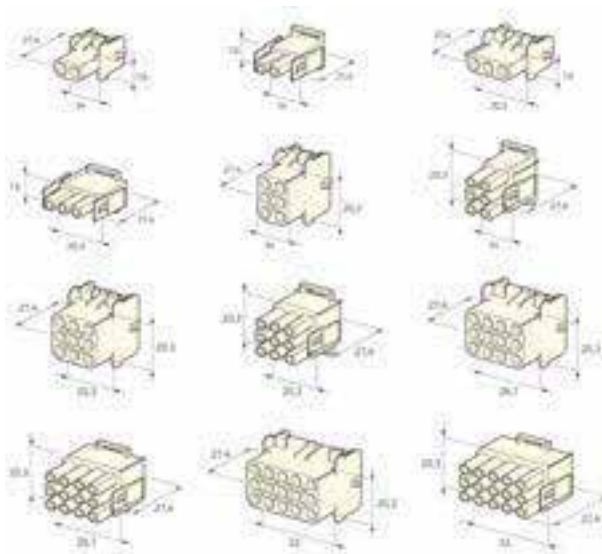

Artikelnummer	⏏	♀	↔	📦
Zakje verpakking				
OS.26010	1	M	OS.26020	10
OS.26020	1	F	OS.26010	10
OS.26030	2	M	OS.26040	10
OS.26040	2	F	OS.26030	10
OS.26050	3	M	OS.26060	10
OS.26060	3	F	OS.26050	10
OS.26110	6	M	OS.26120	10
OS.26120	6	F	OS.26110	10
OS.26130	9	M	OS.26140	10
OS.26140	9	F	OS.26130	10
OS.26150	12	M	OS.26160	10
OS.26160	12	F	OS.26150	10
OS.26170	15	M	OS.26180	10
OS.26180	15	F	OS.26170	10

KABELSCHOENEN VOOR "MATE-N-LOK" KOPPELINGEN

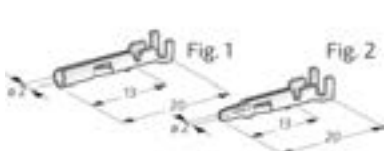

Artikelnummer	L	⊙	♀	Opmerkingen	📷	📦
Doos verpakking						
OS.01200	dia. 2.0 mm	0.5 - 2.5 mm ²	F	"MATE-N-LOCK"	1	200
OS.01210	dia. 2.0 mm	0.5 - 2.5 mm ²	M	"MATE-N-LOCK"	2	200

UNIVERSELE AMP KOPPELINGEN

Geleverd zonder kabelschoenen

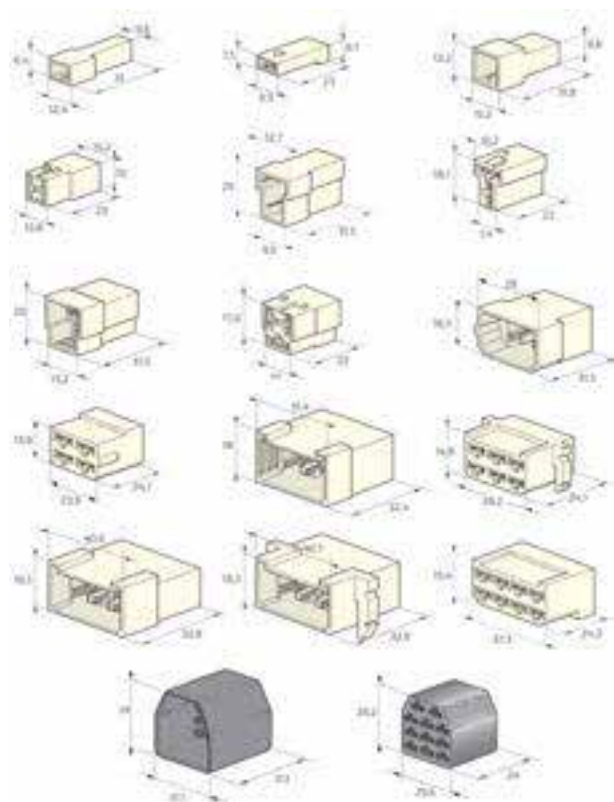

Artikelnummer	☰	♀	↔	📦
Zakje verpakking				
OS.10160	1	M	OS.10150	100
OS.10150	1	F	OS.10160	100
OS.10180	2	M	OS.10170	50
OS.10170	2	F	OS.10180	50
OS.10200	2	M	OS.10190	50
OS.10190	2	F	OS.10200	50
OS.10220	3	M	OS.10210	50
OS.10210	3	F	OS.10220	50
OS.10240	4	M	OS.10230	25
OS.10230	4	F	OS.10240	25
OS.10260	6	M	OS.10250	25
OS.10250	6	F	OS.10260	25
OS.10280	8	M	OS.10270	20
OS.10270	8	F	OS.10280	20
OS.10290	8	F	OS.10280	10
OS.10296	11	M	OS.10295	10
OS.10295	11	F	OS.10296	10

KABELSCHOENEN VOOR UNIVERSELE AMP KOPPELINGEN

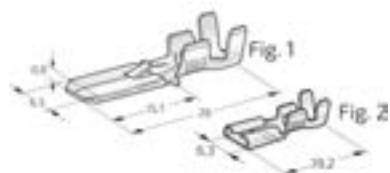

Artikelnummer	L	⊙	♀	Opmerkingen	📦	📦
Doos verpakking						
OS.01660	6.3 x 0.8 mm	1.0 - 2.5 mm ²	M		1	100
OS.01650	6.3 x 0.35 mm	1.0 - 2.5 mm ²	F		2	100

DEUTSCH KOPPELINGEN



Artikelnummer	Beschrijving	📦
Doos verpakking		
OS.85101	Kit met vrouwelijke Deutsch koppeling + 2 kabelschoenen	
OS.85106	Vrouwelijke Deutsch koppeling, 6 poorten + kabelschoenen	1

SETS MET KOPPELINGEN

Voor platte kabelschoenen 6,3mm



Artikelnummer	Inhoud	
Blister verpakking		
HF.001001	Universele AMP koppelingen 1 spoor: 1x M + 1x V Platte kabelschoenen 1,0 tot 2,5mm ² : 1x M + 1x V	1
HF.001002	Universele AMP koppelingen 2 sporen: 1x M + 1x V Platte kabelschoenen 1,0 tot 2,5mm ² : 2x M + 2x V	1
HF.001003	Universele AMP koppelingen 2 sporen: 1x M + 1x V Platte kabelschoenen 1,0 tot 2,5mm ² : 2x M + 2x V	1
HF.001004	Universele AMP koppelingen 3 sporen: 1x M + 1x V Platte kabelschoenen 1,0 tot 2,5mm ² : 3x M + 3x V	1
HF.001005	Universele AMP koppelingen 4 sporen: 1x M + 1x V Platte kabelschoenen 1,0 tot 2,5mm ² : 4x M + 4x V	1
HF.001006	Universele AMP koppelingen 6 sporen: 1x M + 1x V Platte kabelschoenen 1,0 tot 2,5mm ² : 6x M + 6x V	1
HF.001007	Universele AMP koppelingen 8 sporen: 1x M + 1x V Platte kabelschoenen 1,0 tot 2,5mm ² : 8x M + 8x V	1

SETS MET WATERDICHTE KOPPELINGEN

1,5mm



Artikelnummer	Inhoud	
Blister verpakking		
HF.002001	AMP Superseal connectoren 1 spoor: 1x M + 1x F Kabelschoenen 1,0 tot 1,5mm ² : 1x M + 1x F 2x waterdichte pakking	1
HF.002002	AMP Superseal connectoren 2 sporen: 1x M + 1x F Kabelschoenen 1,0 tot 1,5mm ² : 2x M + 2x F 4x waterdichte pakking	1
HF.002003	AMP Superseal connectoren 3 sporen: 1x M + 1x F Kabelschoenen 1,0 tot 1,5mm ² : 3x M + 3x F 6x waterdichte pakking	1
HF.002004	AMP Superseal connectoren 4 sporen: 1x M + 1x F Kabelschoenen 1,0 tot 1,5mm ² : 4x M + 4x F 8x waterdichte pakking	1
HF.002005	AMP Superseal connectoren 5 sporen: 1x M + 1x F Kabelschoenen 1,0 tot 1,5mm ² : 5x M + 5x F 10x waterdichte pakking	1
HF.002006	AMP Superseal connectoren 6 sporen: 1x M + 1x F Kabelschoenen 1,0 tot 1,5mm ² : 6x M + 6x F 12x waterdichte pakking	1

KOFFER MET AMP SUPERSEAL KOPPELINGEN

1,5mm - 460 koppelingen & kabelschoenen



Artikelnummer	Inhoud	
Koffer verpakking		
OS.55460	Koppelingen (60): 1 spoor: 7x M, 7x F 2 sporen: 6x M, 6x F 3 sporen: 5x M, 5x F 4 sporen: 4x M, 4x F 5 sporen: 4x M, 4x F 5 sporen: 4x M, 4x F 6 sporen: 4x M, 4x F Kabelschoenen (200): 100x M, 100x F Sluitdoppen (200): 100x M, 100x F	1

ELEKTRICITEITSDRAAD H05V-K / H07V-K ROL

Voor algemeen gebruik



Operationele temperatuur: +5°C - +70°C
 Max. temperatuur bij kortsluiting: 160°C
 Min. buigstraal: 4x externe dia. (vast)

Artikelnummer		Aders	U ₀ /U (V)	< HAR >	
0.75 mm²					
LK.V075N.50		0.21 mm	300 / 500	H05V-K	50 m
LK.V075R.50		0.21 mm	300 / 500	H05V-K	50 m
1.00 mm²					
LK.V100N.50		0.21 mm	300 / 500	H05V-K	50 m
LK.V100R.50		0.21 mm	300 / 500	H05V-K	50 m
LK.V100B.50		0.21 mm	300 / 500	H05V-K	50 m
LK.V100V.50		0.21 mm	300 / 500	H05V-K	50 m
LK.V100J.50		0.21 mm	300 / 500	H05V-K	50 m
LK.V100W.50		0.21 mm	300 / 500	H05V-K	50 m
LK.V100G.50		0.21 mm	300 / 500	H05V-K	50 m
LK.V100M.50		0.21 mm	300 / 500	H05V-K	50 m
1.50 mm²					
LK.V150N.50		0.26 mm	450 / 750	H07V-K	50 m
LK.V150R.50		0.26 mm	450 / 750	H07V-K	50 m
LK.V150B.50		0.26 mm	450 / 750	H07V-K	50 m
LK.V150V.50		0.26 mm	450 / 750	H07V-K	50 m
LK.V150J.50		0.26 mm	450 / 750	H07V-K	50 m
LK.V150W.50		0.26 mm	450 / 750	H07V-K	50 m
LK.V150G.50		0.26 mm	450 / 750	H07V-K	50 m
LK.V150M.50		0.26 mm	450 / 750	H07V-K	50 m
2.50 mm²					
LK.V250N.50		0.26 mm	450 / 750	H07V-K	50 m
LK.V250R.50		0.26 mm	450 / 750	H07V-K	50 m
LK.V250B.50		0.26 mm	450 / 750	H07V-K	50 m
LK.V250V.50		0.26 mm	450 / 750	H07V-K	50 m
LK.V250J.50		0.26 mm	450 / 750	H07V-K	50 m
LK.V250W.50		0.26 mm	450 / 750	H07V-K	50 m
LK.V250G.50		0.26 mm	450 / 750	H07V-K	50 m
LK.V250M.50		0.26 mm	450 / 750	H07V-K	50 m
4.00 mm²					
LK.V400N.50		0.31 mm	450 / 750	H07V-K	50 m
LK.V400R.50		0.31 mm	450 / 750	H07V-K	50 m
6.00 mm²					
LK.V600N.50		0.31 mm	450 / 750	H07V-K	50 m
LK.V600R.50		0.31 mm	450 / 750	H07V-K	50 m

ELEKTRICITEITSDRAAD H05V-K / H07V-K OP BOBIJN

Voor algemeen gebruik



Operationele temperatuur: +5°C - +70°C
 Max. temperatuur bij kortsluiting: 160°C
 Min. buigstraal: 4x externe dia. (vast)

















Artikelnummer		Aders	AC	DC	< HAR >	
1.00 mm²						
LK.B100N.50		0.21 mm	50 V	75 V	H05V-K	50 m
LK.B100R.50		0.21 mm	50 V	75 V	H05V-K	50 m
LK.B100B.50		0.21 mm	50 V	75 V	H05V-K	50 m
LK.B100V.50		0.21 mm	50 V	75 V	H05V-K	50 m
LK.B100J.50		0.21 mm	50 V	75 V	H05V-K	50 m
LK.B100W.50		0.21 mm	50 V	75 V	H05V-K	50 m
LK.B100M.50		0.21 mm	50 V	75 V	H05V-K	50 m
1.50 mm²						
LK.B150N.50		0.26 mm	50 V	75 V	H07V-K	50 m
LK.B150R.50		0.26 mm	50 V	75 V	H07V-K	50 m
LK.B150B.50		0.26 mm	50 V	75 V	H07V-K	50 m
LK.B150V.50		0.26 mm	50 V	75 V	H07V-K	50 m
LK.B150J.50		0.26 mm	50 V	75 V	H07V-K	50 m
LK.B150W.50		0.26 mm	50 V	75 V	H07V-K	50 m
LK.B150M.50		0.26 mm	50 V	75 V	H07V-K	50 m
2.50 mm²						
LK.B250N.50		0.26 mm	50 V	75 V	H07V-K	50 m
LK.B250R.50		0.26 mm	50 V	75 V	H07V-K	50 m
LK.B250B.50		0.26 mm	50 V	75 V	H07V-K	50 m
LK.B250V.50		0.26 mm	50 V	75 V	H07V-K	50 m
LK.B250J.50		0.26 mm	50 V	75 V	H07V-K	50 m
LK.B250W.50		0.26 mm	50 V	75 V	H07V-K	50 m
4.00 mm²						
LK.B400N.50		0.31 mm	50 V	75 V	H07V-K	50 m
LK.B400R.50		0.31 mm	50 V	75 V	H07V-K	50 m
6.00 mm²						
LK.B600N.50		0.31 mm	50 V	75 V	H07V-K	50 m
LK.B600R.50		0.31 mm	50 V	75 V	H07V-K	50 m
2x 0.50 mm²						
LK.BH2X050.50		0.21 mm	50 V	75 V	H07V-K	50 m
2x 0.75 mm²						
LK.BH2X075.50		0.21 mm	50 V	75 V	H07V-K	50 m

ELEKTRICITEITSDRAAD H05V-K / H07V-K IN DOOS

Voor algemeen gebruik



Operationele temperatuur: +5°C - +70°C
 Max. temperatuur bij kortsluiting: 160°C
 Min. buigstraal: 4x externe dia. (vast)























Artikelnummer		Dia.Ext	Aders	U ₀ /U (V)	< HAR >	
0.75 mm²						
LK.C075N.50		50	0.21 mm	300 / 500	H05V-K	50 m
LK.C075R.50		50	0.21 mm	300 / 500	H05V-K	50 m
1.00 mm²						
LK.C100N.50		50	0.21 mm	300 / 500	H05V-K	50 m
LK.C100R.50		50	0.21 mm	300 / 500	H05V-K	50 m
LK.C100B.50		50	0.21 mm	300 / 500	H05V-K	50 m
LK.C100V.50		50	0.21 mm	300 / 500	H05V-K	50 m
LK.C100J.50		50	0.21 mm	300 / 500	H05V-K	50 m
LK.C100W.50		50	0.21 mm	300 / 500	H05V-K	50 m
LK.C100M.50		50	0.21 mm	300 / 500	H05V-K	50 m
LK.C100G.50		50	0.21 mm	300 / 500	H05V-K	50 m
1.50 mm²						
LK.C150N.50		50	0.26 mm	450 / 750	H07V-K	50 m
LK.C150R.50		50	0.26 mm	450 / 750	H07V-K	50 m
LK.C150B.50		50	0.26 mm	450 / 750	H07V-K	50 m
LK.C150V.50		50	0.26 mm	450 / 750	H07V-K	50 m
LK.C150J.50		50	0.26 mm	450 / 750	H07V-K	50 m
LK.C150W.50		50	0.26 mm	450 / 750	H07V-K	50 m
LK.C150M.50		50	0.26 mm	450 / 750	H07V-K	50 m
LK.C150G.50		50	0.26 mm	450 / 750	H07V-K	50 m
2.50 mm²						
LK.C250N.50		50	0.26 mm	450 / 750	H07V-K	50 m
LK.C250R.50		50	0.26 mm	450 / 750	H07V-K	50 m
LK.C250B.50		50	0.26 mm	450 / 750	H07V-K	50 m
LK.C250V.50		50	0.26 mm	450 / 750	H07V-K	50 m
LK.C250J.50		50	0.26 mm	450 / 750	H07V-K	50 m
LK.C250W.50		50	0.26 mm	450 / 750	H07V-K	50 m
LK.C250M.50		50	0.26 mm	450 / 750	H07V-K	50 m
LK.C250G.50		50	0.26 mm	450 / 750	H07V-K	50 m
4.00 mm²						
LK.C400N.50		50	0.31 mm	450 / 750	H07V-K	50 m
LK.C400R.50		50	0.31 mm	450 / 750	H07V-K	50 m
6.00 mm²						
LK.C600N.50		50	0.31 mm	450 / 750	H07V-K	50 m
LK.C600R.50		50	0.31 mm	450 / 750	H07V-K	50 m

ELEKTRICITEITSDRAAD H05V-K / H07V-K IN BLISTER

Voor algemeen gebruik



Operationele temperatuur: +5°C - +70°C
 Max. temperatuur bij kortsluiting: 160°C
 Min. buigstraal: 4x externe dia. (vast)

Artikelnummer		Dia.Ext	Aders	U ₀ /U (V)	< HAR >	
1.00 mm²						
LK.A100N		10	0.21 mm	300 / 500	H05V-K	10 m
LK.A100R		10	0.21 mm	300 / 500	H05V-K	10 m
LK.A100B		10	0.21 mm	300 / 500	H05V-K	10 m
LK.A100V		10	0.21 mm	300 / 500	H05V-K	10 m
LK.A100J		10	0.21 mm	300 / 500	H05V-K	10 m
LK.A100W		10	0.21 mm	300 / 500	H05V-K	10 m
LK.A100M		10	0.21 mm	300 / 500	H05V-K	10 m
1.50 mm²						
LK.A150N		10	0.26 mm	450 / 750	H07V-K	10 m
LK.A150R		10	0.26 mm	450 / 750	H07V-K	10 m
LK.A150B		10	0.26 mm	450 / 750	H07V-K	10 m
LK.A150V		10	0.26 mm	450 / 750	H07V-K	10 m
LK.A150J		10	0.26 mm	450 / 750	H07V-K	10 m
LK.A150W		10	0.26 mm	450 / 750	H07V-K	10 m
LK.A150G		10	0.26 mm	450 / 750	H07V-K	10 m
LK.A150M		10	0.26 mm	450 / 750	H07V-K	10 m
2.50 mm²						
LK.A250N		10	0.26 mm	450 / 750	H07V-K	10 m
LK.A250R		10	0.26 mm	450 / 750	H07V-K	10 m
LK.A250B		10	0.26 mm	450 / 750	H07V-K	10 m
LK.A250V		10	0.26 mm	450 / 750	H07V-K	10 m
LK.A250J		10	0.26 mm	450 / 750	H07V-K	10 m
LK.A250W		10	0.26 mm	450 / 750	H07V-K	10 m
LK.A250M		10	0.26 mm	450 / 750	H07V-K	10 m

MULTI-GELEIDINGSKABEL A05VV-F OP ROL

Flexibele kabel



Operationele temperatuur: +5°C - +60°C
 Max. temperatuur bij kortsluiting: 150°C
 Min. buigstraal: 4x externe dia. (mobiel) 3x externe dia. (vast)

Artikelnummer	Nb.Cond	Aders	U _o /U (V)	< HAR >	
0.50 mm²					
LK.P5X050.75	5	0.20 mm	300 / 500	A05VV-F	75 m
0.75 mm²					
LK.P2X075.50	2	0.20 mm	300 / 500	A05VV-F	50 m
LK.P3X075.50	3	0.20 mm	300 / 500	A05VV-F	50 m
LK.P5X075.50	5	0.20 mm	300 / 500	A05VV-F	50 m
LK.P6X075.50	6	0.20 mm	300 / 500	A05VV-F	50 m
LK.P7X075.75	7	0.20 mm	300 / 500	A05VV-F	75 m
1.00 mm²					
LK.P2X100.50	2	0.20 mm	300 / 500	A05VV-F	50 m
LK.P3X100.50	3	0.20 mm	300 / 500	A05VV-F	50 m
LK.P4X100.50	4	0.20 mm	300 / 500	A05VV-F	50 m
LK.P5X100.50	5	0.20 mm	300 / 500	A05VV-F	50 m
LK.P7X100.50	7	0.20 mm	300 / 500	A05VV-F	50 m
1.50 mm²					
LK.P2X150.50	2	0.30 mm	300 / 500	A05VV-F	50 m
LK.P3X150.50	3	0.30 mm	300 / 500	A05VV-F	50 m
LK.P4X150.50	4	0.30 mm	300 / 500	A05VV-F	50 m
LK.P5X150.50	5	0.30 mm	300 / 500	A05VV-F	50 m
LK.P7X150.50	7	0.30 mm	300 / 500	A05VV-F	50 m
2.50 mm²					
LK.P2X250.50	2	0.30 mm	300 / 500	A05VV-F	50 m
LK.P3X250.50	3	0.30 mm	300 / 500	A05VV-F	50 m
LK.P5X250.50	5	0.30 mm	300 / 500	A05VV-F	50 m
4.00 mm²					
LK.P2X400.50	2	0.30 mm	300 / 500	A05VV-F	50 m
6.00 mm²					
LK.P2X600.50	2	0.30 mm	300 / 500	A05VV-F	50 m

MONTAGEDRAAD / ACCUDRAAD

Met dubbele PVC-isolatie



Isolatie: Polyvinylchloride
 Omgevingstemperatuur: 70°C in normale omgeving & 50°C in brandgevaarlijke omgeving
 Max. temperatuur bij kortsluiting: 150°C
 Min. installatie temperatuur: + 5°C

Artikelnummer	Dia.Ext	Aders	U _o /U (V)	< HAR >	
16.00 mm²					
LK.R16.25	11.00 mm	0.31 mm	450 / 750		25 m
25.00 mm²					
LK.R25.25	13.00 mm	0.31 mm	450 / 750		25 m
35.00 mm²					
LK.R35.25	15.00 mm	0.31 mm	450 / 750		25 m
50.00 mm²					
LK.R50.25	16.50 mm	0.31 mm	450 / 750		25 m
70.00 mm²					
LK.R70.25	18.00 mm	0.31 mm	450 / 750		25 m
95.00 mm²					
LK.R95.25	22.50 mm	0.31 mm	450 / 750		25 m
120.00 mm²					
LK.R120.25	24.00 mm	0.31 mm	450 / 750		25 m

FLKK "PLATTE" KABEL

Dubbel PVC isolatie

















Artikelnummer	Aders	U ₀ /U (V)	< HAR >	
2x 1.50 mm ²				
LK.F2X150.50		0.25 mm	300 / 500	FLKK 50 m

MONTAGE / ACCUDRAAD

PVC-isolatie - Extra soepel "Simplex"



Isolatie: Polyvinylchloride
 Omgevingstemperatuur: 70°C in normale omgeving & 50°C in brandgevaarlijke omgeving
 Max. temperatuur bij kortsluiting: 160°C

Artikelnummer	Dia.Ext	Aders	U ₀ /U (V)	< HAR >	
10.00 mm ²					
LK.D10N.25		6.70 mm	0.21 mm	450 / 750	25 m
LK.D10R.25		6.70 mm	0.21 mm	450 / 750	25 m
16.00 mm ²					
LK.D16N.25		8.20 mm	0.31 mm	450 / 750	25 m
LK.D16R.25		8.20 mm	0.31 mm	450 / 750	25 m
25.00 mm ²					
LK.D25N.25		10.20 mm	0.31 mm	450 / 750	25 m
LK.D25R.25		10.20 mm	0.31 mm	450 / 750	25 m
35.00 mm ²					
LK.D35N.25		11.60 mm	0.31 mm	450 / 750	25 m
LK.D35R.25		11.60 mm	0.31 mm	450 / 750	25 m
50.00 mm ²					
LK.D50N.25		13.60 mm	0.31 mm	450 / 750	25 m
LK.D50R.25		13.60 mm	0.31 mm	450 / 750	25 m
70.00 mm ²					
LK.D70N.25		15.60 mm	0.31 mm	450 / 750	25 m
LK.D70R.25		15.60 mm	0.31 mm	450 / 750	25 m
95.00 mm ²					
LK.D95N.25		18.20 mm	0.31 mm	450 / 750	25 m
LK.D95R.25		18.20 mm	0.31 mm	450 / 750	25 m

KABELWARTELS

Nyon - Met borgmoer en sluitring - IP68





Artikelnummer	Beschrijving	
Zak verpakking		
PE.PG0007	PG 07 - Max. 6.0mm	25
PE.PG0009	PG 09 - Max. 7.0mm	25
PE.PG0011	PG 11 - Max. 9.6mm	25
PE.PG0013	PG 13 - Max. 11.7mm	25
PE.PG0016	PG 16 - Max. 12.9mm	25

DOORVOERTULE (NYLON)

Voor tules van 0,8 tot 3,2mm



Artikelnummer	Beschrijving	
Zak verpakking		
PF.N00008	Dia. 7.9mm	100
PF.N00010	Dia. 9.5mm	100
PF.N00013	Dia. 13.0mm	100
PF.N00016	Dia. 15.9mm	100
PF.N00019	Dia. 18.9mm	100
PF.N00022	Dia. 22.0mm	100
PF.N00025	Dia. 25.1mm	100

Artikelnummer	Beschrijving	
Zak verpakking		
PF.NC0008	Knop voor PF.N00008	100
PF.NC0010	Knop voor PF.N00010	100
PF.NC0013	Knop voor PF.N00013	100
PF.NC0016	Knop voor PF.N00016	100
PF.NC0019	Knop voor PF.N00019	100
PF.NC0022	Knop voor PF.N00022	100
PF.NC0025	Knop voor PF.N00025	100

DOORVOERTULE (RUBBER)



Artikelnummer	Beschrijving	
Zak verpakking		
PF.C00032	Dia. int. 3.2mm	100
PF.C00048	Dia. int. 4.8mm	100
PF.C00064	Dia. int. 6.4mm	100
PF.C00080	Dia. int. 8.0mm	100
PF.C00095	Dia. int. 9.5mm	100
PF.C00130	Dia. int. 13.0mm	100
PF.C00160	Dia. int. 16.0mm	100
PF.C00190	Dia. int. 19.0mm	100

VERSTELBARE KLEMMEN

Aluminium



Artikelnummer	Beschrijving	
Zak verpakking		
OR.SC1	Dia Max. 6mm	250
OR.SC2	Dia Max. 10mm	250
OR.SC5	Dia Max. 6mm - Max. kabel: 2,5mm ² Economisch model	100
OR.SC6	Dia Max. 10mm - Max. kabel: 4mm ² Economisch model	100

VERSTELBARE ZELFHECHTENDE KLEMMEN

Nylon



Artikelnummer	Beschrijving	
Zak verpakking		
OR.AP08	Dia. Max.: 10,3mm	100
OR.AP10	Dia. Max.: 12,5mm	100
OR.AP12	Dia. Max.: 15,4mm	100

LUSTERKLEMMEN

PP zwart - Max. 85°C - CE



Artikelnummer	Beschrijving	
Doos verpakking		
DR.1102	Sectie 2.5mm ²	10
DR.1122	Sectie 4.0mm ²	10
DR.1142	Sectie 6.0mm ²	10
DR.1152	Sectie 16.0mm ²	10
Blister verpakking		
HF.001102	2x DR.1102	1
HF.001122	2x DR.1122	1

SCHROEF LUSTERKLEMMEN

30A - Max. 600V - 215°C



Artikelnummer	Beschrijving	
Zak verpakking		
DR.3004	4 aansluitklemmen	5
DR.3006	6 aansluitklemmen	5
DR.3008	8 aansluitklemmen	5

SCHROEF DISTRIBUTIE LUSTERKLEMMEN

Messing



Artikelnummer	Beschrijving	
Bulk		
DR.1005	5 schroeven 4mm + 2 aansluitklemmen M5 Max. 100A Afmetingen: 15x75x2mm	1
DR.5010	10 schroeven 4mm + 2 aansluitklemmenr M6 Max. 150A Afmetingen: 19x120x2,4mm	1
DR.4001	4 schroeven 6mm Max. 100A Afmetingen: 15x75x2mm	1
DR.4002	4 schroeven 6mm Max. 150A Afmetingen: 19x120x2.4mm	1
Artikelnummer		
Beschrijving		
Bulk		
DR.1005C	ABS deksel voor lusterklemmen (kort model)	1
DR.5010C	ABS deksel voor lusterklemmen (lang model)	1
DR.5010PC	Transparant PC deksel voor lusterklemmen (lang model)	1

WATERDICHT VERDEELDOOS









Artikelnummer	Beschrijving	
Bulk		
MR.440019	Waterdichte doos 6 verbindingen	1

SPIRAALVORMIGE DRAADGELEIDER

PE



Omgevingstemperatuur: -20°C - +50°C







Artikelnummer		Dia.Int	Dia.Ext	Stap	Capaciteit	
Zak verpakking						
MW.04		4.8 mm	6 mm	8.5 mm	4.0 - 50mm	10 m
MW.06		6.6 mm	8 mm	13 mm	6.0 - 60mm	10 m
MW.06W		6.6 mm	8 mm	13 mm	6.0 - 60mm	10 m
MW.08		8.4 mm	10 mm	13 mm	7.5 - 60mm	10 m
MW.09		10.3 mm	12 mm	15 mm	9.0 - 65mm	10 m
MW.12		13 mm	15 mm	17 mm	12.0 - 70mm	10 m

SNEL DRAADGELEIDER

PE



Omgevingstemperatuur: -20°C - +50°C







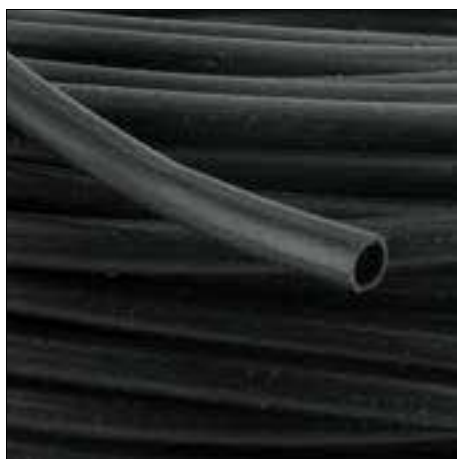





Artikelnummer		Dia.Nom	Stap	Capaciteit	Dikte	
Zak verpakking						
MQ.10		8 mm	10 mm	Max. 10mm	8 mm	5 m
MQ.16		15 mm	14 mm	Max. 16mm	15 mm	5 m
MQ.23		20 mm	17 mm	Max. 23mm	20 mm	5 m
MQ.29		25 mm	20 mm	Max. 29mm	25 mm	5 m
Artikelnummer	Beschrijving					
Zak verpakking						
MQ.10C	Draadgeleider voor MQ.10					10
MQ.16C	Draadgeleider voor MQ.16					10
MQ.23C	Draadgeleider voor MQ.23					10
MQ.29C	Draadgeleider voor MQ.29					10

SOEPELE KABELBUIS

DIN 40621 - PVC



Omgevingstemperatuur: -40°C - +125°C

Artikelnummer		Dia.Int	Dia.Ext	Dikte	
Zak verpakking					
MB.004		4 mm	5.0 mm	0.50 mm	100 m
MB.005		5 mm	6.2 mm	0.60 mm	100 m
MB.006		6 mm	7.2 mm	0.60 mm	100 m
MB.007		7 mm	8.4 mm	0.70 mm	100 m
MB.008		8 mm	9.4 mm	0.70 mm	100 m
MB.010		10 mm	11.4 mm	0.70 mm	100 m
MB.012		12 mm	13.6 mm	0.80 mm	100 m
MB.014		14 mm	16.0 mm	1.00 mm	50 m
MB.016		16 mm	18.0 mm	1.00 mm	50 m
MB.018		18 mm	20.0 mm	1.00 mm	50 m
MB.020		20 mm	22.4 mm	1.20 mm	50 m

KABELBUIS ZONDER SNEDE

PA 6 - Norm Iveco-Fiat 11-8223



Max. 120°C

Artikelnummer		Dia.Int	Dia.Ext	Stap	
Zak verpakking					
ME.204	<input type="checkbox"/>	4.40 mm	7.40 mm	2.00 mm	100 m
ME.207	<input type="checkbox"/>	6.60 mm	10.00 mm	2.75 mm	100 m
ME.209	<input type="checkbox"/>	8.40 mm	11.70 mm	2.30 mm	50 m
ME.210	<input type="checkbox"/>	9.90 mm	13.00 mm	2.55 mm	50 m
ME.212	<input type="checkbox"/>	12.70 mm	15.80 mm	3.00 mm	50 m
ME.217	<input type="checkbox"/>	16.60 mm	21.20 mm	2.90 mm	50 m
ME.222	<input type="checkbox"/>	21.30 mm	25.40 mm	2.90 mm	50 m
ME.226	<input type="checkbox"/>	25.80 mm	31.20 mm	2.90 mm	25 m
ME.229	<input type="checkbox"/>	29.00 mm	34.50 mm	4.15 mm	25 m

KABELBUIS MET SNEDE

PP - Norm Fiat auto 91223



Max. 135°C

Artikelnummer		Dia.Int	Dia.Ext	Stap	
Zak verpakking					
ME.104	<input type="checkbox"/>	4.50 mm	7.30 mm	2.00 mm	100 m
ME.106	<input type="checkbox"/>	6.00 mm	9.55 mm	2.80 mm	50 m
ME.108	<input type="checkbox"/>	9.00 mm	13.35 mm	3.20 mm	50 m
ME.110	<input type="checkbox"/>	11.00 mm	16.40 mm	3.20 mm	50 m
ME.113	<input type="checkbox"/>	13.00 mm	18.50 mm	3.20 mm	50 m
ME.117	<input type="checkbox"/>	16.00 mm	21.20 mm	3.50 mm	50 m
ME.119	<input type="checkbox"/>	19.00 mm	24.10 mm	4.00 mm	50 m
ME.119.12	<input type="checkbox"/>	19.00 mm	24.10 mm	4.00 mm	1.2 m
ME.122	<input type="checkbox"/>	23.00 mm	28.70 mm	4.80 mm	50 m
ME.126	<input type="checkbox"/>	26.00 mm	31.70 mm	4.80 mm	50 m
ME.129	<input type="checkbox"/>	29.00 mm	35.90 mm	5.10 mm	50 m

ZELFDOVEND KABELBUIS MET SNEDE

PP - Norm Fiat auto 91223



Max. 135°C

Artikelnummer		Dia.Int	Dia.Ext	Stap	
Zak verpakking					
ME.004	<input type="checkbox"/>	4.50 mm	7.30 mm	2.00 mm	100 m
ME.006	<input type="checkbox"/>	6.00 mm	9.55 mm	2.80 mm	100 m
ME.008	<input type="checkbox"/>	9.00 mm	13.35 mm	3.20 mm	50 m
ME.010	<input type="checkbox"/>	11.00 mm	16.40 mm	3.20 mm	50 m
ME.013	<input type="checkbox"/>	13.00 mm	18.50 mm	3.20 mm	50 m
ME.017	<input type="checkbox"/>	16.00 mm	21.20 mm	3.50 mm	50 m
ME.019	<input type="checkbox"/>	19.00 mm	24.10 mm	4.00 mm	50 m
ME.022	<input type="checkbox"/>	23.00 mm	28.70 mm	4.80 mm	50 m
ME.026	<input type="checkbox"/>	26.00 mm	31.70 mm	4.80 mm	50 m
ME.029	<input type="checkbox"/>	29.00 mm	35.90 mm	5.10 mm	50 m

BEVESTIGINGEN VOOR DRAADGELEIDER - PLASTIEK

Breedte: 12,7mm - Gat: 5,1mm



Artikelnummer	Beschrijving	
Zak verpakking		
HC.P00003	Dia. Max. 2.9mm	1
HC.P00006	Dia. Max. 5.9mm	1
HC.P00009	Dia. Max. 9.1mm	1
HC.P00012	Dia. Max. 12.2mm	1
HC.P00014	Dia. Max. 13.8mm	1
HC.P00019	Dia. Max. 18.6mm	1
HC.P00022	Dia. Max. 22.2mm	1

BEVESTIGINGEN VOOR DRAADGELEIDER MET RUBBER BESCHERMING

Verzinkt staal - Breedte: 12,7mm - Gat: 5,0mm



Artikelnummer	Beschrijving	
Zak verpakking		
HC.000006	Dia. Max. 6.3mm	100
HC.000010	Dia. Max. 9.5mm	100
HC.000013	Dia. Max. 12.7mm	100
HC.000016	Dia. Max. 14.2mm	100
HC.000019	Dia. Max. 19.0mm	100
HC.000022	Dia. Max. 22.2mm	100
HC.000025	Dia. Max. 25.4mm	100

REKBARE GEVLOCHTEN DRAADGELEIDER - TYPE BSPET

PET

Vertraagde ontbranding



Artikelnummer	Dia.Nom	Dia.Int	Dia.Ext	
Zak verpakking				
MT.0032	3.2 mm	2.37 mm	6.35 mm	10 m
MT.0064	6.4 mm	3.17 mm	9.53 mm	10 m
MT.0095	9.5 mm	4.76 mm	15.88 mm	10 m
MT.0127	12.7 mm	6.35 mm	19.05 mm	10 m
MT.0190	19.0 mm	12.70 mm	31.75 mm	10 m
Blister verpakking				
MT.B0032	3.2 mm	2.37 mm	6.35 mm	2 m
MT.B0064	6.4 mm	3.17 mm	9.53 mm	2 m
MT.B0095	9.5 mm	4.76 mm	15.88 mm	2 m
MT.B0127	12.7 mm	6.35 mm	19.05 mm	2 m
MT.B0190	19.0 mm	12.70 mm	31.75 mm	2 m

Omgevingstemperatuur: -40°C - +125°C
Anti-UV

REKBARE GEVLOCHTEN ZELFDOVENDE DRAADGELEIDER - TYPE BSPET

PET - UL E304566

Vertraagde ontbranding



Omgevingstemperatuur: -40°C - +125°C
Anti-UV































Artikelnummer	Dia.Nom	Dia.Int	Dia.Ext	
Zak verpakking				
MT.1032	3.2 mm	2.37 mm	6.35 mm	10 m
MT.1064	6.4 mm	3.17 mm	9.53 mm	10 m
MT.1095	9.5 mm	4.76 mm	15.88 mm	10 m
MT.1127	12.7 mm	6.35 mm	19.05 mm	10 m
MT.1190	19.0 mm	12.70 mm	31.75 mm	10 m

WARMTEKRIMPBARE DRAADGELEIDER 2:1 - TYPE G5

UL224 - Polyolefine



Krimptemperatuur: >70°C
Omgevingstemperatuur: -55°C - +125°C
Vertraagde ontbranding
Overige kleuren verkrijgbaar op aanvraag









Artikelnummer		inch	Dia.A	Dia.B	Dikte	
Zakje verpakking						
MA.024N		3/32	2.4 mm	1.20 mm	0.44 mm	5x 1.20m
MA.024R		3/32	2.4 mm	1.20 mm	0.44 mm	5x 1.20m
MA.032N		1/8	3.2 mm	1.60 mm	0.44 mm	5x 1.20m
MA.032R		1/8	3.2 mm	1.60 mm	0.44 mm	5x 1.20m
MA.048N		3/16	4.8 mm	2.40 mm	0.56 mm	5x 1.20m
MA.048R		3/16	4.8 mm	2.40 mm	0.56 mm	5x 1.20m
MA.064N		1/4	6.4 mm	3.20 mm	0.56 mm	5x 1.20m
MA.064R		1/4	6.4 mm	3.20 mm	0.56 mm	5x 1.20m
MA.095N		3/8	9.5 mm	4.75 mm	0.56 mm	5x 1.20m
MA.095R		3/8	9.5 mm	4.75 mm	0.56 mm	5x 1.20m
MA.127N		1/2	12.7 mm	6.35 mm	0.69 mm	5x 1.20m
MA.127R		1/2	12.7 mm	6.35 mm	0.69 mm	5x 1.20m
MA.190N		3/4	19.1 mm	9.55 mm	0.77 mm	5x 1.20m
MA.190R		3/4	19.1 mm	9.55 mm	0.77 mm	5x 1.20m
MA.254N		1	25.4 mm	12.70 mm	0.87 mm	5x 1.20m
MA.254W		1	25.4 mm	12.70 mm	0.87 mm	5x 1.20m
Doos verpakking						
MA.032BOX		1/8	3.2 mm	1.60 mm	0.44 mm	10 m
MA.048BOX		3/16	4.8 mm	2.40 mm	0.56 mm	10 m
MA.064BOX		1/4	6.4 mm	3.20 mm	0.56 mm	10 m
MA.095BOX		3/8	9.5 mm	4.75 mm	0.56 mm	10 m
MA.127BOX		1/2	12.7 mm	6.35 mm	0.69 mm	8 m
MA.190BOX		3/4	19.1 mm	9.55 mm	0.77 mm	7 m
MA.254BOX		1	25.4 mm	12.70 mm	0.87 mm	5 m
Blister verpakking						
MA.B024		3/32	2.4 mm	1.20 mm	0.44 mm	2 m
MA.B032		1/8	3.2 mm	1.60 mm	0.44 mm	2 m
MA.B048		3/16	4.8 mm	2.40 mm	0.56 mm	2 m
MA.B064		1/4	6.4 mm	3.20 mm	0.56 mm	2 m
MA.B095		3/8	9.5 mm	4.75 mm	0.56 mm	2 m
MA.B127		1/2	12.7 mm	6.35 mm	0.69 mm	2 m
MA.B190		3/4	19.1 mm	9.55 mm	0.77 mm	2 m

WARMTEKRIMPBARE DRAADGELEIDER 2:1 - TYPE G5

Moffen, 5cm - UL224 - Polyolefine



Krimptemperatuur: >70°C
 Omgevingstemperatuur: -55°C - +125°C
 Vertraagde ontbranding
 Overige kleuren verkrijgbaar op aanvraag

Artikelnummer		inch	Dia.A	Dia.B	Dikte	
Zak verpakking						
MA.M024N		3/32	2.4 mm	1.20 mm	0.44 mm	500
MA.M032N		1/8	3.2 mm	1.60 mm	0.44 mm	500
MA.M048N		3/16	4.8 mm	2.40 mm	0.56 mm	500
MA.M064N		1/4	6.4 mm	3.20 mm	0.56 mm	500
MA.M095N		3/8	9.5 mm	4.75 mm	0.56 mm	500
MA.M127N		1/2	12.7 mm	6.35 mm	0.69 mm	500
MA.M190N		3/4	19.1 mm	9.55 mm	0.77 mm	500

WARMTEKRIMPBARE DRAADGELEIDER 2:1 - 5CM MOFFEN IN BLISTER

Moffen, 5cm - UL224 - Polyolefine



Krimptemperatuur: >70°C
 Omgevingstemperatuur: -55°C - +125°C
 Vertraagde ontbranding
 Overige kleuren verkrijgbaar op aanvraag

Artikelnummer		Inhoud	
Blister verpakking			
HF.000032		Zwarte moffen 5cm: 12x 3.20mm	1
HF.000048		Zwarte moffen 5cm: 12x 4.80mm	1
HF.000064		Zwarte moffen 5cm: 12x 6.40mm	1
HF.000095		Zwarte moffen 5cm: 12x 9.50mm	1
HF.000127		Zwarte moffen 5cm: 12x 12.70mm	1
HF.000190		Zwarte moffen 5cm: 12x 19.00mm	1
HF.000250		Zwarte moffen 5cm: 2x 3.20mm, 4x 4.80mm, 2x 6.40mm, 2x 9.50mm, 1x 12.70mm, 1x 19.00mm	1

WARMTEKRIMPBARE DRAADGELEIDER 2:1 - TYPE G5

Sets 5 kleuren: Groen, rood, geel, blauw & transparant - UL224 - Polyolefine



Krimptemperatuur: >70°C
 Omgevingstemperatuur: -55°C - +125°C
 Vertraagde ontbranding
 1 staaf van 1.20m in elke kleur

Artikelnummer		inch	Dia.A	Dia.B	Dikte	
Zakje verpakking						
MA.032KIT		1/8	3.2 mm	1.60 mm	0.44 mm	5x 1.20m
MA.048KIT		3/16	4.8 mm	2.40 mm	0.56 mm	5x 1.20m
MA.064KIT		1/4	6.4 mm	3.20 mm	0.56 mm	5x 1.20m
MA.095KIT		3/8	9.5 mm	4.75 mm	0.69 mm	5x 1.20m
MA.127KIT		1/2	12.7 mm	6.35 mm	0.77 mm	5x 1.20m
MA.190KIT		3/4	19.1 mm	9.55 mm	0.77 mm	5x 1.20m

WARMTEKRIMPBARE DRAADGELEIDER 2:1 - TYPE G5

Kit met 8x 1.20m (zwart) - UL224 - Polyolefine



Krimptemperatuur: >70°C
Omgevingstemperatuur: -55°C - +125°C
Vertraagde ontbranding



Artikelnummer	Inhoud	
Zakje verpakking		
MA.X8KIT	8 staven van 1.20m: 2x 4.8mm - 2.40mm 2x 6.4mm - 3.20mm 2x 9.5mm - 4.75mm 2x 12.7mm - 6.35mm	1

WARMTEKRIMPBARE TAPE 2:1 - TYPE HPVC

UL224 - Polyolefine



Krimptemperatuur: >50°C
Omgevingstemperatuur: tot +105°C
Vertraagde ontbranding

Artikelnummer		Dikte	
Zak verpakking			
MA.R020N		0.07 mm	100 m
MA.R020R		0.07 mm	100 m

WARMTEKRIMPBARE DRAADGELEIDER 3:1 - TYPE G5-3X

UL224 - Polyolefine



Krimptemperatuur: >70°C
Omgevingstemperatuur: -55°C - +125°C
Vertraagde ontbranding
Andere kleuren ook verkrijgbaar op aanvraag

Artikelnummer		inch	Dia.A	Dia.B	Dikte	
Zakje verpakking						
MA.W030		1/8	3.00 mm	1.00 mm	0.55 mm	5x 1.20m
MA.W045		3/16	4.80 mm	1.50 mm	0.60 mm	5x 1.20m
MA.W060		1/4	6.40 mm	2.00 mm	0.65 mm	5x 1.20m
MA.W090		3/8	9.50 mm	3.00 mm	0.75 mm	5x 1.20m
MA.W120		1/2	12.70 mm	4.00 mm	0.80 mm	5x 1.20m

WARMTEKRIMPBARE DRAADGELEIDER 3:1 - TYPE AIS-3X

Met lijm - UL224 - Polyolefine



Krimptemperatuur: >80°C
Omgevingstemperatuur: -45°C - +110°C
Vertraagde ontbranding
Andere kleuren ook verkrijgbaar op aanvraag

Artikelnummer		inch	Dia.A	Dia.B	Dikte	
Zakje verpakking						
MA.D030		1/8	3.00 mm	1.00 mm	1.00 mm	5x 1.20m
MA.D048		3/16	4.80 mm	1.60 mm	1.00 mm	5x 1.20m
MA.D060		1/4	6.00 mm	2.00 mm	1.00 mm	5x 1.20m
MA.D090		3/8	9.00 mm	3.00 mm	1.40 mm	5x 1.20m
MA.D120		1/2	12.00 mm	4.00 mm	1.78 mm	5x 1.20m
MA.D240		1	25.00 mm	8.00 mm	2.54 mm	5x 1.20m

DOZEN MET WARMTEKRIMPBARE DRAADGELEIDER 2:1 - TYPE G5

UL224 - Polyolefine



























Krimptemperatuur: >70°C
 Omgevingstemperatuur: -55°C - +125°C
 Vertraagde ontbranding

Artikelnummer	Inhoud	
Koffer verpakking		
MA.799	Moffen (127): 12,7x100mm: 2 zwart, 1 transparant, 1 wit, 1 geel, 1 rood, 1 blauw, 1 groen 9,5x70mm: 2 zwart, 1 transparant, 1 wit, 1 geel, 1 rood, 1 blauw, 1 groen 6,4x70mm: 4 zwart, 2 transparant, 2 wit, 2 geel, 2 rood, 2 blauw, 2 groen 4,8x35mm: 3 zwart, 3 transparant, 3 wit, 3 geel, 3 rood, 3 blauw, 3 groen 3,2x35mm: 3 zwart, 3 transparant, 3 wit, 3 geel, 3 rood, 3 blauw, 3 groen 2,4x35mm: 4 zwart, 4 transparant, 4 wit, 4 geel, 4 rood, 4 blauw, 4 groen 1,5x35mm: 4 zwart, 4 transparant, 4 wit, 4 geel, 4 rood, 4 blauw, 4 groen	1
MA.599	Moffen (160): 1,2x100mm: 60 zwart 2,4x100mm: 35 zwart 3,2x100mm: 25 zwart 4,8x100mm: 20 zwart 6,4x100mm: 10 zwart 9,5x100mm: 10 zwart	1
MA.699	Moffen (160): 1,2x100mm: 10 groen, 10 rood, 10 geel, 10 blauw, 10 transparant, 10 wit 2,4x100mm: 6 groen, 6 rood, 5 geel, 6 blauw, 6 transparant, 5 wit 3,2x100mm: 4 groen, 4 rood, 4 geel, 4 blauw, 5 transparant, 4 wit 4,8x100mm: 3 groen, 4 rood, 3 geel, 3 blauw, 4 transparant, 3 wit 6,4x100mm: 1 groen, 2 rood, 2 geel, 2 blauw, 2 transparant, 1 wit 9,5x100mm: 1 groen, 2 rood, 2 geel, 2 blauw, 2 transparant, 1 wit	1

NYLON KABELBINDERS PA6.6

Eenvoudig klemmen







Artikelnummer		Ø MAX		Opmerkingen	
Zak verpakking					
MV.25075N		2.5 x 75mm	16 mm	11 daN	100
MV.25100N		2.5 x 100mm	24 mm	11 daN	100
MV.25100W		2.5 x 100mm	24 mm	11 daN	100
MV.25135N		2.5 x 135mm	35 mm	11 daN	100
MV.25160N		2.5 x 160mm	40 mm	11 daN	100
MV.25200N		2.5 x 200mm	55 mm	11 daN	100
MV.35140N		3.5 x 140mm	36 mm	20 daN	100
MV.35140W		3.5 x 140mm	36 mm	20 daN	100
MV.35200N		3.5 x 200mm	55 mm	20 daN	100
MV.35200W		3.5 x 200mm	55 mm	20 daN	100
MV.35280N		3.5 x 280mm	80 mm	20 daN	100
MV.35360N		3.5 x 360mm	103 mm	20 daN	100
MV.45140N		4.5 x 140mm	33 mm	20 daN	100
MV.45160N		4.5 x 160mm	38 mm	28 daN	100
MV.45200N		4.5 x 200mm	51 mm	28 daN	100
MV.45250N		4.5 x 250mm	68 mm	28 daN	100
MV.45280N		4.5 x 280mm	76 mm	28 daN	100
MV.45360N		4.5 x 360mm	101 mm	28 daN	100
MV.45360W		4.5 x 360mm	101 mm	28 daN	100
MV.45380N		4.5 x 380mm	110 mm	28 daN	100
MV.45430N		4.5 x 430mm	123 mm	28 daN	100
MV.75180N		7.5 x 180mm	44 mm	65 daN	100
MV.75200N		7.5 x 200mm	48 mm	65 daN	100
MV.75240N		7.5 x 240mm	62 mm	65 daN	100
MV.75280N		7.5 x 280mm	76 mm	65 daN	100
MV.75320N		7.5 x 320mm	88 mm	65 daN	100
MV.75360N		7.5 x 360mm	101 mm	65 daN	100
MV.75450N		7.5 x 450mm	130 mm	65 daN	100
MV.90430N		9.0 x 430mm	118 mm	80 daN	100
MV.90550N		9.0 x 550mm	160 mm	80 daN	100
MV.90780N		9.0 x 780mm	235 mm	80 daN	50
MV.130230N		13.0 x 230mm	50 mm	114 daN	50
MV.130280N		13.0 x 280mm	70 mm	114 daN	50
MV.130380N		13.0 x 380mm	102 mm	114 daN	50
MV.130480N		13.0 x 480mm	120 mm	114 daN	50

NYLON KABELBINDERS PA6.12

Versterkt



Artikelnummer		Ø MAX		Opmerkingen	
Zak verpakking					
MV.60115HD		6.0 x 115mm	22mm	35 daN Enkele kop	100
MV.90115HD		9.0 x 115mm	22 mm	35 daN Enkele kop	100
MV.90180HD		9.0 x 180mm	45 mm	35 daN Enkele kop	100
MV.90265HD		9.0 x 265mm	70 mm	45 daN Dubbele kop	100
MV.90360HD		9.0 x 360mm	95 mm	45 daN Dubbele kop	100
MV.90500HD		9.0 x 500mm	140 mm	45 daN Dubbele kop	100

ONDERZETTERS NYLON PA.66



Artikelnummer		Ø MAX		Opmerkingen	
Zak verpakking					
MV.600019N		19x19mm	4 mm	10 daN	100
MV.600019W		19x19mm	4 mm	10 daN	100
MV.600028N		29x29mm	6 mm	16 daN	100
MV.600028W		29x29mm	6 mm	16 daN	100

SET MET KABELBINDERS (450 STK)



Artikelnummer	Inhoud	
Koffer verpakking		
MV.00450	Kabelbinders (450): 100x2,5mm: 50x wit, 50x zwart, 50x rood, 50x geel, 50x groen, 50x blauw 150x3,6mm: 25x wit, 25x zwart, 25x rood, 25x blauw 200x4,8mm: 25x wit, 25x zwart	1

SET MET KABELBINDERS (1000 STK)



Artikelnummer	Inhoud	
Koffer verpakking		
MV.01000	Kabelbinders (1000): 100x2,5mm: 200x wit, 100x rood, 100x blauw, 100x groen, 100x geel 200x4,8mm: 350x wit 280x4,8mm: 50x wit	1

SLANGKLEMMEN DIN 3017

RVS AISI430 - SW7 schroef met schroevendraaiergleuf - Breedte 9mm



Artikelnummer	Beschrijving	
Zak verpakking		
HC.090711	Min. 7mm - Max. 11mm (schroef 4.8mm)	100
HC.090812	Min. 8mm - Max. 12mm	100
HC.091016	Min. 10mm - Max. 16mm	100
HC.091220	Min. 12mm - Max. 20mm	100
HC.091625	Min. 16mm - Max. 25mm	100
HC.092032	Min. 20mm - Max. 32mm	100
HC.092540	Min. 25mm - Max. 40mm	100
HC.093250	Min. 32mm - Max. 50mm	50
HC.094060	Min. 40mm - Max. 60mm	50
HC.095070	Min. 50mm - Max. 70mm	50
HC.096080	Min. 60mm - Max. 80mm	25
HC.097090	Min. 70mm - Max. 90mm	25
Blister verpakking		
HF.990711	10x HC.090711	1
HF.990812	10x HC.090812	1
HF.991016	10x HC.091016	1
HF.991220	10x HC.091220	1
HF.991625	10x HC.091625	1
HF.992032	10x HC.092032	1
HF.992540	5x HC.092540	1
HF.993250	5x HC.093250	1
HF.994060	5x HC.094060	1
HF.995070	2x HC.095070	1
HF.990010	10 gemengde beugels (van 7/11mm tot 50/70mm)	1
Mini-display verpakking		
HC.DISPLAY	Display 110 stk 10x 8-12mm, 10x 10-16mm, 10x 12-20mm 10x 16-25mm, 10x 20-32mm, 10x 25-40mm 10x 30-45mm, 10x 32-50mm, 10x 40-60mm 10x 50-70mm, 10x 60-80mm	1
Koffer verpakking		
HC.KIT	Kit met 100 stk 10x 8-12mm, 10x 10-16mm, 15x 12-20mm, 15x 16-25mm, 15x 20-32mm, 15x 25-40mm, 10x 32-50mm, 5x 40-60mm, 5x 50-70mm	1
Artikelnummer		
Beschrijving		
Blister verpakking		
HC.SW007	Zeshoekige flexibele schroevendraaier DIN 3017	1

KRIMPTANGEN



Artikelnummer	Beschrijving	
Doos verpakking		
EI.K047	Klemtang voor buisvormige kabelschoenen 10 tot 120mm ²	1
Blister verpakking		
EI.K038	Klemtang voor niet-geïsoleerde kabelschoenen 0,50 tot 6,00mm ² Met krachtmechanisme	1
EI.K036	Klemtang voor geïsoleerde kabelschoenen 0,50 tot 6,00mm ² Met krachtmechanisme	1
EI.K033	Professionele klemtang voor geïsoleerde kabelschoenen 0,50 tot 6,00mm ² Met stripplaat	1
EI.K034	Klemtang voor geïsoleerde kabelschoenen 0,50 tot 6,00mm ² Met stripplaat	1

KLEMMENSET

7-delig



Artikelnummer	Beschrijving	
Koffer verpakking		
EI.3007	1 striptang 1 kruiskopschroevendraaier 1 krimptang met verwisselbare klemmen: geïsoleerde kabelschoenen (0,50-6,00mm ²), niet-geïsoleerde kabelschoenen (0,50-6,00mm ²), buisvormige kabelschoenen (1,50-10,00mm ²), buisvormige kabelvormige (1,50-10,00mm ²), eindstukken (0,50-4,00mm ²)	1

STRIPTANG



Artikelnummer	Beschrijving	
Bulk		
EI.2756	Voor kabels 0,50 tot 6,00mm ² Met kabelsnijder (max 6,00mm ²)	1

LASLAMP



Artikelnummer	Beschrijving	
Bulk		
EI.3103	Multifunctionele set inclusief: - Kop hete lucht - Soldeerkop - Dubbele nauwkeurigheidspunt - Punt 2,4mm - Verwarmd blad	1

SOLDEERDRAAD



Artikelnummer	Beschrijving	
Bulk		
EI.3211	Soldeer dia.: 2mm - 40% tin, 250g	1
EI.3212	Soldeer dia.: 2mm - 40% tin, 500g	1

DUBBELZIJDIGE TAPE







Artikelnummer	Beschrijving	
Zakje verpakking		
CK.850	Dubbelzijdige tape 12mm	10m
CK.851	Dubbelzijdige tape 15mm	10m
CK.852	Dubbelzijdige tape 19mm	10m
CK.853	Dubbelzijdige tape 25mm	10m

PVC TAPE

Dikte: 0,19mm



Artikelnummer	Beschrijving	
Zak verpakking		
CK.751N	 Breedte: 19mm Lengte: 10m	10
CK.751R	 Breedte: 19mm Lengte: 10m	10
CK.751G	 Breedte: 19mm Lengte: 10m	10
CK.751M	 Breedte: 19mm Lengte: 10m	10
CK.800N	 Breedte: 50mm Lengte: 10m	4
CK.751Z	Kleur selectie 10stk Breedte: 19mm Lengte: 10m	10
Blister verpakking		
HF.900752	1x CK.751N + Ax CK.751R	1

U

US.0549.4T 18
 US.0549.5 12
 US.0549.5T 18
 US.0550.4 11
 US.0550.4T 18
 US.0550.5 11
 US.0550.5T 18
 US.0551 13
 US.0551T 19
 US.0555 10
 US.0559.5 10
 US.0559.8 10
 US.0561 14
 US.0562 14
 US.0566 14
 US.0619 9
 US.0621 14
 US.0622 14
 US.0633 8
 US.0634 8
 US.0634T 15
 US.0635 8
 US.0635T 15
 US.0636 8
 US.0636T 15
 US.0638 8
 US.0644 13
 US.0644T 18
 US.0653 8
 US.0654 8
 US.0654T 15
 US.0655 8
 US.0655T 15
 US.0656 8
 US.0656T 15
 US.0658 8
 US.0658T 15
 US.0659.5 10
 US.0659.8 10
 US.0660 8
 US.0663 13
 US.0664 13
 US.0665 13
 US.0665T 18
 US.0666 13
 US.0674 8
 US.0675 8
 US.0675T 15
 US.0676 8
 US.0676T 15
 US.0678 8
 US.0678T 15
 US.0680 8
 US.0680T 15
 US.0685 13
 US.0685T 18
 US.0701 13
 US.0702 13
 US.0703 13
 US.0740 9
 US.0740T 16
 US.0741.5 10
 US.0741.8 10
 US.0742.5 10
 US.0742.8 10
 US.0840 9
 US.0840T 16
 US.0849 12
 US.0850 11
 US.0905 11
 US.2241TS 19
 US.2251TS 19
 US.2261TS 19
 US.2341TS 19
 US.2540 20
 US.2540T 17
 US.2541 11
 US.2541T 17

U

US.2542 11
 US.2542T 17
 US.2543 11
 US.2543T 17
 US.2547 12
 US.2548 12
 US.2549.4 12
 US.2549.5 12
 US.2550.4 12
 US.2550.5 12
 US.2555 11
 US.2559 11
 US.2568 19
 US.2569 19
 US.2571 19
 US.2659 11
 US.2740 20
 US.2740T 17
 US.2741 11
 US.2742 11
 US.2840 20
 US.2840T 17
 US.2951 20
 US.2952 20
 US.2953 20
 V
 VR.0510 9
 VR.0519 9
 VR.0520 9
 VR.0540 9
 VR.0540T 16
 VR.0541 10
 VR.0541T 16
 VR.0542 10
 VR.0542T 16
 VR.0543 10
 VR.0543T 16
 VR.0544 10
 VR.0545 13
 VR.0545T 19
 VR.0546 13
 VR.0546T 19
 VR.0547 11
 VR.0547T 18
 VR.0548 12
 VR.0548T 18
 VR.0549.4 12
 VR.0549.4T 18
 VR.0549.5 12
 VR.0549.5T 18
 VR.0550.4 11
 VR.0550.4T 18
 VR.0550.5 11
 VR.0550.5T 18
 VR.0551 13
 VR.0551T 19
 VR.0555 10
 VR.0559.5 10
 VR.0559.8 10
 VR.0561 14
 VR.0562 14
 VR.0566 14
 VR.0619 9
 VR.0621 14
 VR.0622 14
 VR.0633 8
 VR.0634 8
 VR.0634T 15
 VR.0635 8
 VR.0635T 15
 VR.0636 8
 VR.0636T 15
 VR.0638 8
 VR.0644 13
 VR.0644T 18
 VR.0653 8
 VR.0654 8
 VR.0654T 15

V

VR.0655 8
 VR.0655T 15
 VR.0656 8
 VR.0656T 15
 VR.0658 8
 VR.0658T 15
 VR.0659.5 10
 VR.0659.8 10
 VR.0660 8
 VR.0663 13
 VR.0664 13
 VR.0665 13
 VR.0665T 18
 VR.0666 13
 VR.0674 8
 VR.0675 8
 VR.0675T 15
 VR.0676 8
 VR.0676T 15
 VR.0678 8
 VR.0678T 15
 VR.0680 8
 VR.0680T 15
 VR.0685 13
 VR.0685T 18
 VR.0701 13
 VR.0702 13
 VR.0703 13
 VR.0740 9
 VR.0740T 16
 VR.0741.5 10
 VR.0741.8 10
 VR.0742.5 10
 VR.0742.8 10
 VR.0840 9
 VR.0840T 16
 VR.0849 12
 VR.0850 11
 VR.2241TS 19
 VR.2251TS 19
 VR.2261TS 19
 VR.2341TS 19
 VR.2540 20
 VR.2540T 17
 VR.2541 11
 VR.2541T 17
 VR.2542 11
 VR.2542T 17
 VR.2543 11
 VR.2543T 17
 VR.2547 12
 VR.2548 12
 VR.2549.4 12
 VR.2549.5 12
 VR.2550.4 12
 VR.2550.5 12
 VR.2559 11
 VR.2568 19
 VR.2569 19
 VR.2659 11
 VR.2740 20
 VR.2740T 17
 VR.2741 11
 VR.2742 11
 VR.2840 20
 VR.2840T 17
 VR.2951 20
 VR.2952 20
 VR.2953 20
 Z
 ZB.3000 22
 ZB.4001 23
 ZB.5000 24
 ZB.5535 24
 ZB.5702 23
 ZB.5775 24
 ZB.6000 23

WWW.CASTEELS.FR

WWW.CASTEELS.FR

CASTEELS France sàrl

ZA du Champ de Courses
76560 Doudeville - FRANCE

EXPORT EUROPE & USA

 +32 (0)2 648 35 17

 +32 (0)2 648 65 95

 info@casteels.fr

FRANCE & DOM/TOM

 +33 (0)2 32 70 64 02

 +33 (0)2 32 70 64 20

 contact@casteels.fr